

NON-CONTROLLED COPY

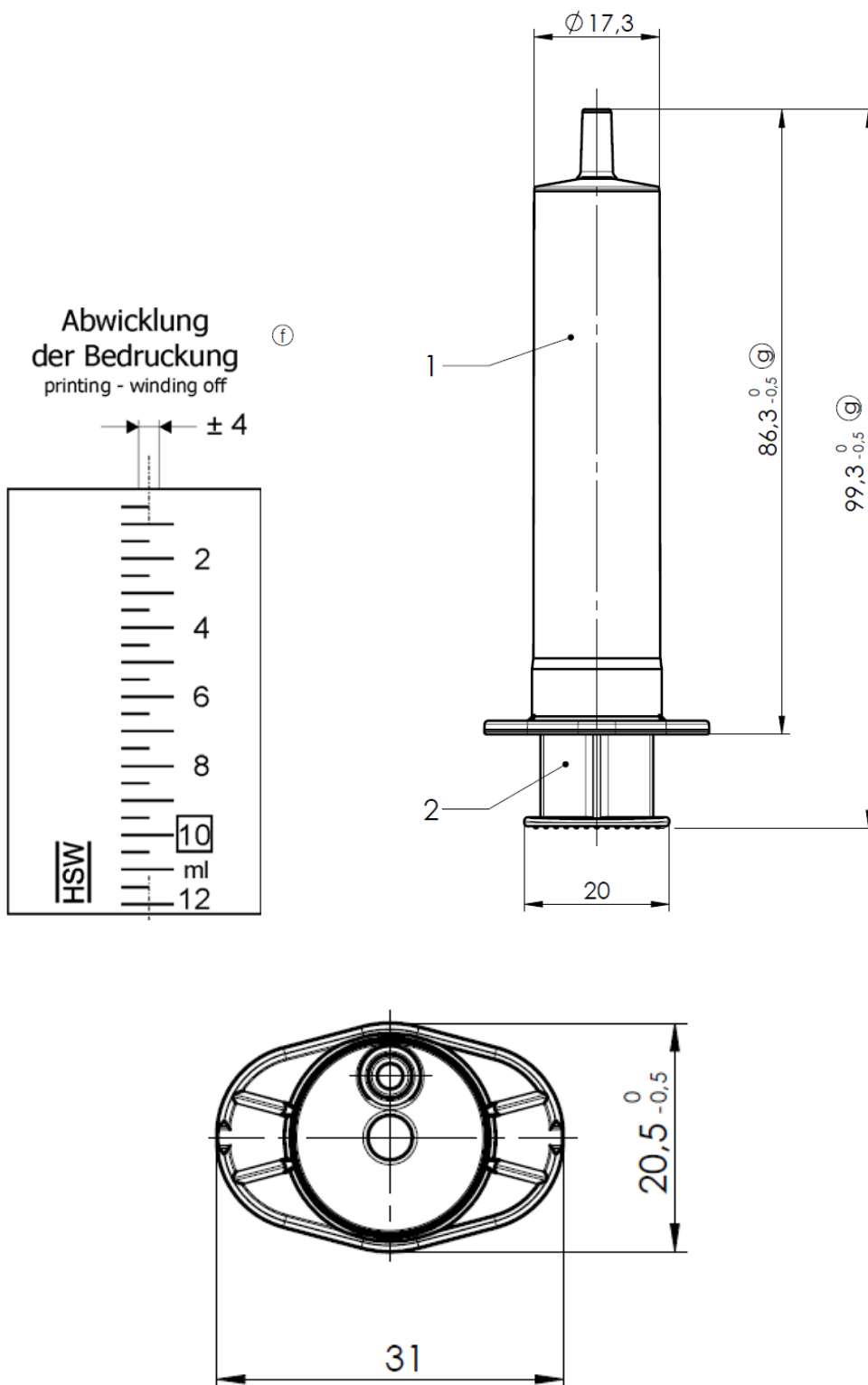

**FOR INFORMATION
PURPOSES ONLY**

HSW NORM-JECT® 10 ml (12 ml), Luer Slip
#4100.000V0 #4100.090D0 #8300020457 – 05.12.2008
Disposable 2-part syringe, Luer Slip

