

Instruction Manual

ibidi Gas Incubation System – Silver Line

for use with ibidi Heating System Slide/Dish – Silver Line

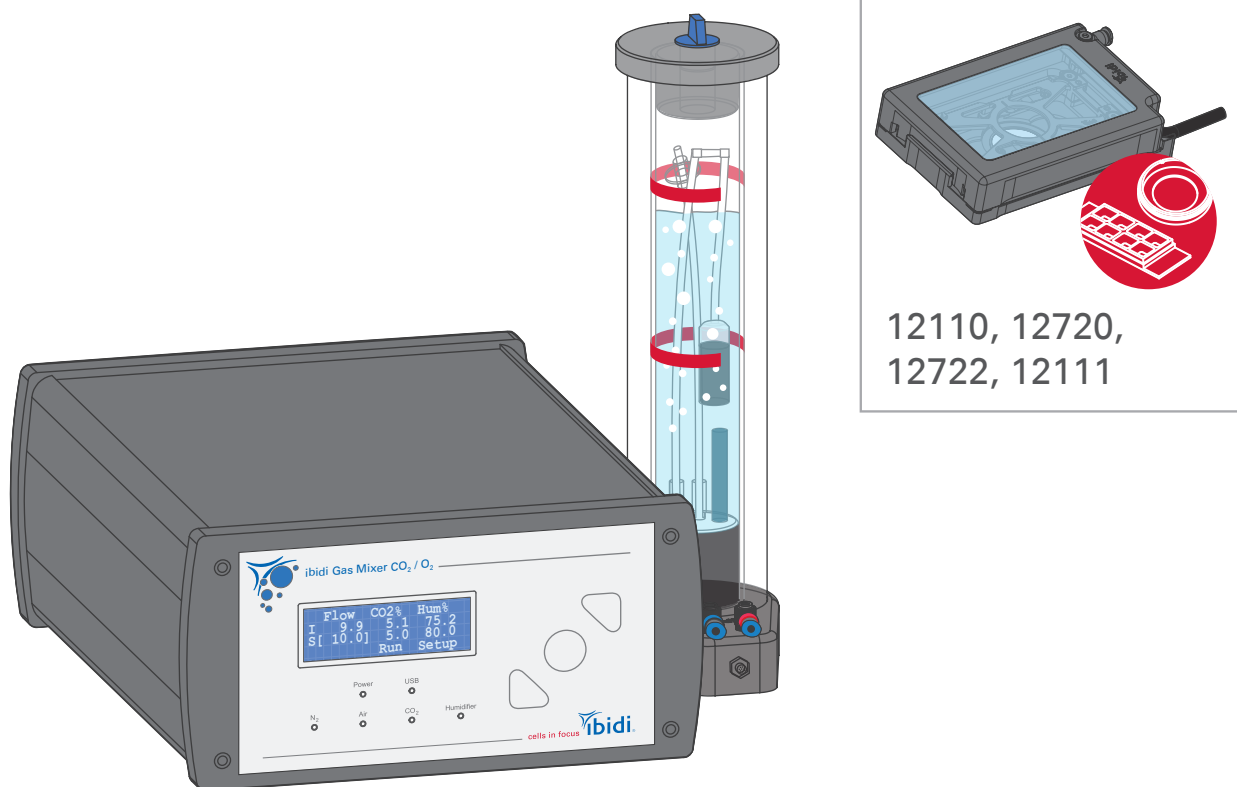

11921 ibidi Gas Incubation System, CO₂ – Silver Line

11923 ibidi Gas Incubation System, CO₂/O₂ – Silver Line

Contact

ibidi GmbH

Lochhamer Schlag 11
82166 Gräfelfing
Germany

Phone: +49 89 / 520 46 17 - 0

Fax: +49 89 / 520 46 17 - 59

E-mail: info@ibidi.de

Internet: ibidi.com

Contents

1	Preamble	6
1.1	Introduction	6
1.2	Safety Symbols	6
1.3	Nomenclature	7
1.4	Specifications	7
1.5	Disclaimer	10
1.6	Safety Considerations	10
1.7	Limited Warranty	12
1.8	Transporting the ibidi Gas Incubation System – Silver Line	12
1.9	Repairing the ibidi Gas Incubation System – Silver Line	13
1.10	Waste Disposal – WEEE/RoHS Compliance Statement	13
1.10.1	EU Directive WEEE	13
1.10.2	EU Directive RoHS	13
1.11	Regulatory Statement	14
2	Intended Use	15
3	Principle	15
4	Equipment	17
4.1	Components of the ibidi Gas Incubation System – Silver Line	17
4.2	Gas Mixer CO ₂ or CO ₂ /O ₂	18
4.3	Humidifying Column	20
4.4	Heated Tubing Package	21
4.5	Humidity Sensor	22

5	Operation	23
5.1	Installation and Connection	23
5.1.1	Connection to the Gas Supply	24
5.1.2	Connection of the Heated Tubing Package and the Humidifying Column	26
5.1.3	Connection of the Humidity Sensor	28
5.1.4	Connection of the Power Supply (and USB optionally)	29
5.2	(Re)-Filling the Humidifying Column	29
5.3	Switching on the System	30
5.4	Setting Parameters with the Front Display	31
5.4.1	Run/Stop Mode	31
5.4.2	Incubation Parameters	32
5.4.3	Setup Menu	33
6	IncuControl Software	35
7	Maintenance	36
7.1	Disinfection and Cleaning	36
7.1.1	Wiping the Outer Surface	36
7.1.2	Cleaning the Column’s Inner Face	36
7.2	Influence of Surrounding Temperature and Airflow	36
8	Troubleshooting	37
8.1	Controller Display Errors	37
8.2	Flow Readings	37
8.3	CO ₂ Channel Readings	38
8.4	O ₂ Channel Readings	39
8.5	Humidity Channel Readings	40
8.6	Humidifying Column	42
8.7	Focus not Stable	42
8.8	Evaporation is Too High	43
8.9	Condensation Inside the Stage Top Incubator	43

1 Preamble

1.1 Introduction

This manual is your guide to using the ibidi Gas Incubation System – Silver Line for cell culture experiments on an optical microscope. It instructs first-time users on how to use the instrument, and serves as a reference for experienced users.

Before using the ibidi Gas Incubation System – Silver Line, please read this instruction manual carefully and make sure that the contents are fully understood. This manual should be easily accessible to the operator at all times during instrument operation. If this manual gets lost, see the online version on ibidi.com or request a replacement via techsupport@ibidi.com.

To ensure safe operation, the ibidi Gas Incubation System – Silver Line must only be operated with the supplied components and according to the instruction manual.

For Research Use Only! Not for use in diagnostic procedures.

The instruction manual covers the ibidi Gas Incubation System, CO₂ – Silver Line (#11921) and the ibidi Gas Incubation System, CO₂/O₂ – Silver Line (#11923).

This version of the manual describes the ibidi Gas Incubation System – Silver Line with the ibidi Heating System Slide/Dish – Silver Line (#12110, #12720, #12722, #12111).

For use of the ibidi Gas Incubation System – Silver Line with the ibidi Heating System 4 Slides – Silver Line (#12130, #12131) or ibidi Heating System Multiwell Plate – Silver Line (#12150, #12724, #12726, #12151) please refer to the instruction manual “[for use with the ibidi Heating System 4 Slides – Silver Line and ibidi Heating System Multiwell Plate – Silver Line](#)”.

1.2 Safety Symbols

Note that the signal words **WARNING**, **CAUTION** and **NOTE** have specific meanings in this manual. Do not proceed beyond a signal word until you have performed the indicated actions. Warning messages in the text are displayed in a gray shaded box. Please see section 1.6 for general safety considerations.



WARNING – A potentially hazardous situation which, if not avoided, could result in serious injury or even death.



CAUTION – A potentially hazardous situation which, if not avoided, could result in minor or moderate injury. It is also used to alert against damaging the equipment or the instrument.



NOTE – Additional information to help achieve optimal instrument and assay performance.

Symbols on the product identification label and back panel of the device:



CE Marking: This symbol indicates the product’s compliance with EU legislation.



This label is positioned on the back of the device and prompts you to read the manual before using the device.



Product disposal: The symbol indicates that this product must be recycled/disposed of separately from other household waste. See page 13 for details.

1.3 Nomenclature

The ibidi Gas Incubation System – Silver Line consists of the following three main components:

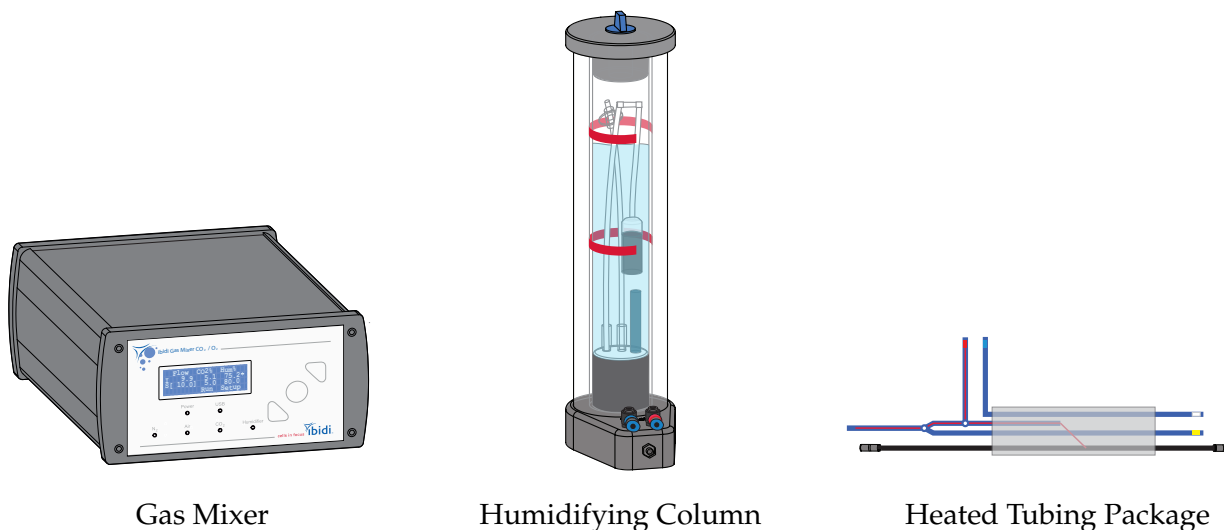

Where adequate, the ibidi Gas Incubation System, CO₂ – Silver Line and the ibidi Gas Incubation System, CO₂/O₂ – Silver Line are hereafter abbreviated and referred to as Gas Incubation System in body text and figure captions.

1.4 Specifications

Table 1: Specifications of the ibidi Gas Incubation System – Silver Line

Electrical Specifications Power Supply	
Protection class	I
International protection marking (IEC 60529)	IP 20
Overvoltage category	II
External power supply	AC 100–240 V, 50/60 Hz, 1.4 A
Input line voltage Gas Mixer	DC 24 V, 5 A, 120 W
Output voltage (to Humidifying Column)	DC 24 V, max. 3.6 A
Operating Conditions	
Operating site	Indoor use only
Operating temperature	18–30°C/64–86°F
Operating humidity	max. 80% relative humidity (RH)
Operating altitude	max. 2000 m (atmospheric pressure 800–1060 hPa/11.6–15.4 psi)
Storage Conditions	-5–50°C/23–122°F, humidity <60% relative humidity (RH)

Table 1: (continued)

Outer Dimensions and Characteristics of the Components	
Gas Mixer	90 × 170 × 230 mm ³ 2230 g/4.9 lbs
Humidifying Column	70 × 110 × 300 mm ³ 660/710/790 g /1.45/1.57/1.74 lbs (empty/min/max)
Heated Tubing Package	0.6 m (between Controller and Column) 1.5 m (between Column and Heated Lid) 82 g/0.18 lbs
Cable for Humidity Sensor	1.5 m
USB cable	1.8 m
Power supply cable	2.0 m (power supply to wall) 1.2 m (power supply to device)
Gas Connections	
Gas tubing material	Polyurethane, hydrolysis resistant
Gas tubing connections	Push-in fittings
Gas Mixer input	ID 4 mm, OD 6 mm
Gas Mixer output and Humidifying Column connection	ID 2.5 mm, OD 4 mm
Connection to the Heated Lid	push-in fitting, ID 2.5 mm, OD 4 mm
Gas Input Requirements	
Compressed air	Purity class: ISO 8573-1:2010 [1:2:1] 1 bar/14.5 psi optimum (0.8–1.2 bar / 11.6–17.4 psi)
Carbon dioxide (CO ₂)	Purity: >99% CO ₂ 1 bar/14.5 psi optimum (0.8–1.2 bar / 11.6–17.4 psi)
Nitrogen (N ₂)*	Purity: >99% N ₂ 1 bar/14.5 psi optimum (0.8–1.2 bar / 11.6–17.4 psi)
*only for the CO ₂ /O ₂ version	
CO₂ Control	
Control range	0–15%
Accuracy	±(0.2%vol. + 3% of reading) e.g. ±0.35% at 5% CO ₂ concentration
Resolution	0.1%
O₂ Control*	
Control range	1–21% (note: settings below 1% are less accurate and a typical minimum value in an ibidi Incubation Chamber is 0.5% O ₂)

Table 1: (continued)

Accuracy	±0.2%vol. (typical) ±0.7%vol. (max.)			
Resolution	0.1%			
Heat-up time	Five minutes before proper operation of sensor			
CO ₂ cross-sensitivity	The O ₂ sensor has some cross-sensitivity to CO ₂ at 0% O ₂ . This manifests as an offset in the measured O ₂ concentration, with typical values shown in the table below:			
	CO ₂ Conc.	Set O ₂ Conc.	Displayed O ₂ Conc.	Actual O ₂ Conc.
	0%	0%	0.1%	0.1%
	5%	0%	0.5%	0.1%
	10%	0%	0.6%	0.1%
Lifetime	Sensor lifetime is three years under continuous operation.			

*only for the CO₂/O₂ version

Humidity Control

Humidity sensor type	Sensirion SHT35-DIS
Control range	20–99% (lower limit dependent on environment and gas supply, min. set humidity is 0%)
Sensor accuracy	±2.5% (max.)
Resolution	0.1%

Humidifying Column Temperature Control*

Control range	45°C to 55°C
Accuracy	±2°C
Resolution	0.1%

*only controllable on the Gas Mixer, not in IncuControl

Flow Control Mixed Gas

Control range	0–20 l/h
Accuracy	±25%
Resolution	0.1%

Humidifying Column

Liquid	Ultra-pure water
Minimum volume	50 ml
Maximum volume	130 ml
Refilling	80 ml (approximately after 7 days at 10 l/h)

1.5 Disclaimer

- ibidi shall not be held liable, either directly or indirectly, for any damage incurred as a result of product use.
- The contents of this manual are subject to change without notice for product improvement.
- This manual is considered complete and accurate at publication.
- This manual does not guarantee the validity of any patent rights or other rights.
- If an ibidi software program doesn't function properly, this may be caused by a conflict from another program operating on the computer. In this case, take corrective action by uninstalling the conflicting product(s).
- ibidi is a registered trademark of ibidi GmbH in Germany and other countries.

1.6 Safety Considerations



WARNING

- Only operate the ibidi Gas Incubation System – Silver Line with the supplied components.
- Only use the cables and plugs delivered with the system. The power plug of the control unit must be inserted in an outlet with a ground (earth) contact.
- Do not replace detachable power cables by power cables with inadequate specifications. By violating these instructions, you risk electric shock and fire.
- Only use extension cables that have a protective ground wire.
- Do not operate the ibidi Gas Incubation System – Silver Line under conditions that pose a risk of explosion, implosion, or the release of gases.
- Only operate the ibidi Gas Incubation System – Silver Line with ultra-pure water.
- Do not place flammable solids, liquids, gases, or gas outlets near the system (e.g., matches, ethanol, propane gas, solvents). Do not bring these products in contact with any other component of the system either.
- Do not operate a damaged ibidi Gas Incubation System – Silver Line. If the housing seems damaged or something is rattling inside the controller, contact the [ibidi technical support](#) for repair.
- Some accessible parts of the ibidi Gas Incubation System – Silver Line (Humidifying Column base, water inside the column, and Heated Tubing Package) can reach temperatures up to 55°C/131°F (60°C/140°F the water inside the column). Avoid touching the temperature-controlled parts of the system when hot.
- The use of medical gases must take place in rooms with appropriate air exchange in order to avoid harmful gas concentrations.



CAUTION

- Ensure that the external power supply is easily accessible. The ibidi Gas Incubation System – Silver Line must be installed in a manner such that none of its components hinders access to the external power supply.
- Immediately replace damaged cords, plugs, or cables to avoid risk of personal injury or damage to the instrument.
- Only ibidi technical staff and technical staff instructed by ibidi are permitted to open and service the ibidi Gas Incubation System – Silver Line.
- The external power supply should not be brought into contact with moisture. If the housing is damaged, the external power supply should not be used.
- Avoid strong magnetic fields and sources of high frequency. The ibidi Gas Incubation System – Silver Line might not function properly when located near a strong magnetic field or high frequency source.
- Avoid vibrations from vacuum pumps, centrifuges, electric motors, processing equipment, and machine tools.
- Avoid dust and corrosive gas. Do not install the ibidi Gas Incubation System – Silver Line where it could be exposed to high levels of dust or to outside air or ventilation outlets.
- Install the ibidi Gas Incubation System – Silver Line in a location that enables easy access for maintenance.
- Do not place heavy objects on the instrument.
- Install the ibidi Gas Incubation System – Silver Line in a horizontal and stable position, such as a table, bench, or desk upon which the instrument is installed.
- The Gas Mixer needs a gas input of 1 bar/14.5 psi. Only operate the Gas Mixer with the pressure indicated in the specifications on page 7.

1.7 Limited Warranty

Products manufactured by ibidi, unless otherwise specified, are warrantied for a period of one year from the date of shipment to be free of defects in materials and workmanship. If any defects in the product are found during this warranty period, ibidi will repair or replace the defective part(s) or product free of charge.

This warranty does not apply to defects resulting from the following:

1. Improper or inadequate installation.
2. Improper or inadequate operation, maintenance, adjustment, or calibration.
3. Unauthorized modification or misuse.
4. Use of unauthorized tubing or fluidic connectors.
5. Use of consumables, disposables, and parts not supplied by an authorized ibidi distributor.
6. Corrosion due to the use of improper solvents, samples, or due to surrounding gases.
7. Accidents beyond ibidi's control, including natural disasters.

This warranty does not cover consumables, such as cell culture chambers and dishes, tubes, fluidic connectors, reagents etc.

The warranty for all parts supplied and repairs provided under this warranty expires on the warranty expiration date of the original product.

1.8 Transporting the ibidi Gas Incubation System – Silver Line

The weight of the Gas Mixer and the Humidifying Column is given in the specifications (Section 1.4). Moving the devices during operation will pose a risk of personal injury or damage to the instrument.

For transport, switch off the Gas Mixer, close all gas input lines and then disconnect all cables and tubing from the controller and peripheral components. Leave the instrument to cool down for approximately five minutes. Carry the devices carefully and avoid mechanical shocks.



WARNING – Close all gas input lines before disconnecting the gas tubing from the Gas Mixer!

1.9 Repairing the ibidi Gas Incubation System – Silver Line

For inquiries concerning repair service contact ibidi GmbH technical support (techsupport@ibidi.com) and provide the model name and serial number of your system.



CAUTION – Do not try to repair the ibidi Gas Incubation System – Silver Line by yourself. Disassembly of the ibidi Gas Incubation System – Silver Line is not allowed. Disassembly poses a risk of personal injury or damage to the devices. Contact ibidi technical support if there is a need to disassemble a device.

1.10 Waste Disposal – WEEE/RoHS Compliance Statement

The European Union (EU) has enacted two directives, the first on product recycling (Waste Electrical and Electronic Equipment, WEEE) and the second on limiting the use of certain substances (Restriction on the use of Hazardous Substances, RoHS).

1.10.1 EU Directive WEEE

The ibidi Gas Incubation System – Silver Line must be disposed of in compliance with the WEEE Directive 2012/19/EC.



This symbol on the product is in accordance with the European Union’s Waste Electrical and Electronic Equipment (WEEE) Directive. The symbol indicates that this product must be recycled/disposed of separately from other household waste. It is the end user’s responsibility to dispose of this product by taking it to a designated WEEE collection facility for the proper collection and recycling of the waste equipment. The separate collection and recycling of waste equipment will help to conserve natural resources and protect human health and the environment. For more information about recycling, please contact your local environmental office, an electrical/electronic waste disposal company or distributor where you purchased the product.

1.10.2 EU Directive RoHS

RoHS conformity is declared in the EU-conformity in Section 1.11.

1.11 Regulatory Statement

EG-Konformitätserklärung EC Declaration of Conformity

Wir / We

ibidi GmbH
Lochhamer Schlag 11
D-82166 Gräfelfing

erklären hiermit die Übereinstimmung des genannten Produktes mit der Richtlinie 2014/35/EU - Niederspannungsrichtlinie und mit der Richtlinie 2014/30/EU über die Elektromagnetische Verträglichkeit.
Bei Änderungen am Produkt, die nicht von uns autorisiert wurden, verliert diese Erklärung ihre Gültigkeit.

We declare the compliance of the product with the requirements of the Directive 2014/35/EU - Low Voltage Directive and with the Directive 2014/30/EU about the Electromagnetic Compatibility.
Any modification to the product, not authorized by us, will invalidate this declaration.

Laborgerät / laboratory equipment:

ibidi Gas Mixer ibiGM2-XXX with ibidi accessories

Der oben beschriebene Gegenstand erfüllt die Vorschriften der Richtlinie 2011/65/EU vom 08. Juni 2011 zur Beschränkung der Verwendung bestimmter gefährlicher Stoffe in Elektro- und Elektronikgeräten.

The object of the declaration described above is in conformity with Directive 2011/65/EU of 8 June 2011 on the restriction of the use of certain hazardous substances in electrical and electronic equipment.

Das Produkt entspricht den unten aufgeführten Normen:
The product meets the requirements of the following standards:

DIN EN 61010-1:2011

Sicherheitsbestimmungen für elektrische Mess-, Steuer-, Regel- und Laborgeräte - Teil 1: Allgemeine Anforderungen Safety requirements for electrical equipment for measurement, control and laboratory use - Part 1: General requirements

DIN EN 61326-1:2013

Elektrische Mess-, Steuer-, Regel und Laborgeräte. EMV-Anforderungen. Allgemeine Anforderungen
Electrical equipment for measurement, control and laboratory use. EMC requirements. General requirements

Das Produkt ist gekennzeichnet mit/ The product is marked with



Gräfelfing, den 27.06.2019
Gräfelfing, 2019-06-27

Ort/Datum
Place/date

Dr. Valentin Kahl
Geschäftsführer

Name, Funktion
Name, Function



Unterschrift
Signature

Diese Erklärung bescheinigt die Übereinstimmung mit den genannten Richtlinien, ist jedoch keine Zusicherung von Eigenschaften. Die Sicherheitshinweise der Produktdokumentation sind zu beachten.

This declaration certifies the conformity to the specified directives but not includes any warranted quality of the instrument. The safety documentation of the product shall be considered in detail.



2 Intended Use

The ibidi Gas Incubation System – Silver Line provides defined gas control for live cell imaging experiments. It is intended to be used with stage top incubators and can be applied on various microscopes. The Gas Incubation System mixes the required gas ratios in the output and actively humidifies this mixed gas output before the gas enters the incubation chamber.

Two versions of the ibidi Gas Incubation System – Silver Line are available: the ibidi Gas Incubation System, CO₂ – Silver Line (#11921) for control of CO₂ concentration and the ibidi Gas Incubation System, CO₂/O₂ – Silver Line (#11923) for control of both, CO₂ and O₂. The O₂ version can additionally downregulate the amount of O₂ in the gas mixture to create hypoxia. Both versions can control the humidity and CO₂ concentration.

To provide a fully controlled stage top incubator the Gas Incubation System can be combined with the ibidi Heating System – Silver Line.

3 Principle

Physiological Conditions in Live Cell Imaging

Cells react sensitively to changes in their environment. Factors such as temperature, humidity, and CO₂/O₂ levels significantly influence the outcome of cell culture assays. In order to achieve biologically relevant and reproducible results, it is crucial to maintain optimal conditions on the microscope stage during live cell imaging experiments.

To enable high-quality live cell imaging under physiological conditions, the following parameters need to be considered:

Environment:

- Temperature
- Carbon Dioxide (CO₂) Levels and pH of the Medium
- Humidity and Evaporation
- Oxygen (O₂) Levels

Optical Aspects:

- Condensation
- Imaging Method and Photon Dose

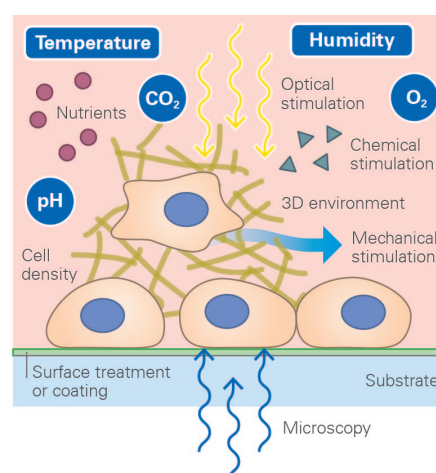

Figure 1: Live cell imaging conditions.

The ibidi Gas Incubation System provides a controlled atmosphere of gas (CO₂ or CO₂ and O₂) as well as a defined humidity in the emitted gas stream that is flushed continuously through the incubation chamber. Oxygen can be reduced during the experiment, enabling the user to perform hypoxia experiments (CO₂/O₂ version only).

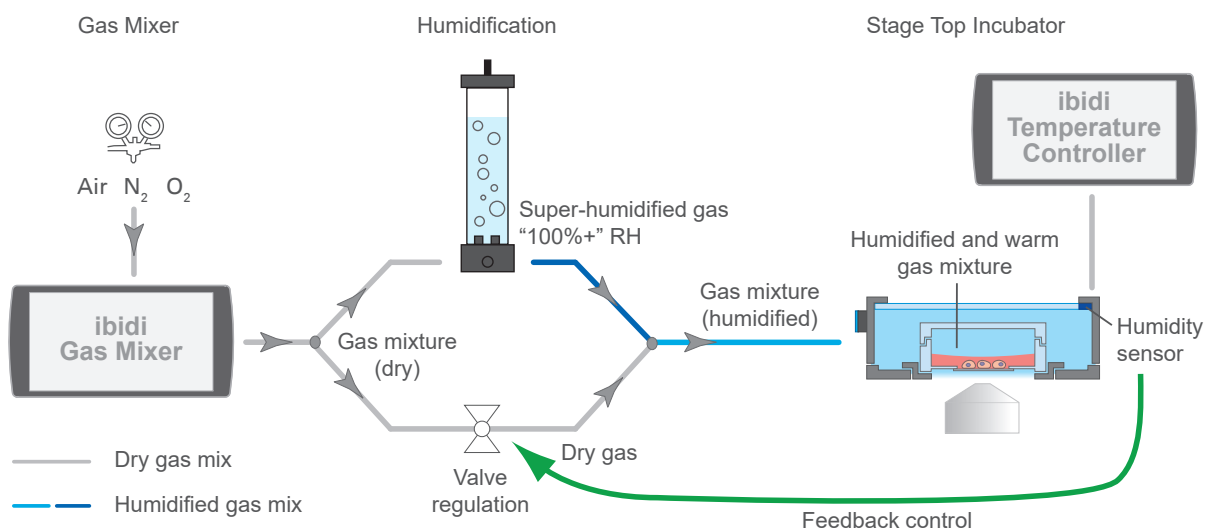

Figure 2: Schematic view of the ibidi Stage Top Incubation System, combining the ibidi Heating System with the ibidi Gas Incubation System.

In combination with the ibidi Heating System, it supplies complete incubator conditions for your live cell imaging directly on the microscope stage.

Humidity in ambient air can lead to condensation on all surfaces, especially on the lids of cell culture vessels. If these surfaces are within the optical pathway, small water droplets will cause light scattering. This diminishes the optical quality of transmitted light microscopy (i.e., phase contrast). To ensure the highest image quality, condensation on any surface should be prevented during live cell imaging experiments.

The independently controlled Heated Lid of the ibidi Heating System prevents from condensation during live cell imaging. By heating the lid to a temperature higher than the plate, a vertical temperature gradient is created. This gradient, and active humidity control prevent the formation of condensation on the lid of the cell culture vessel.

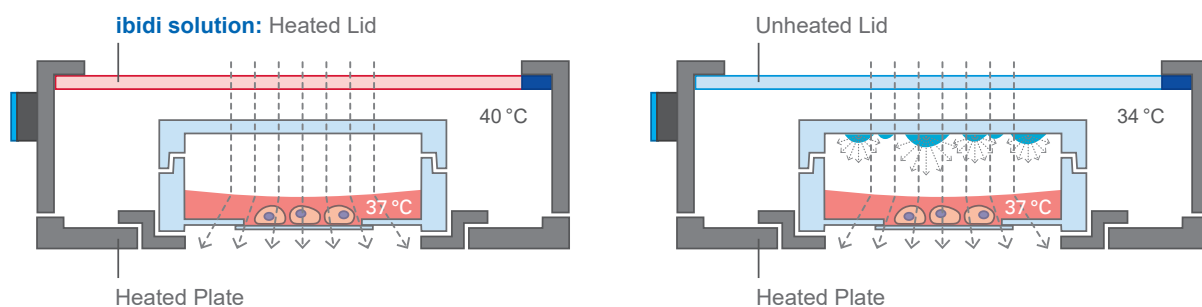

Figure 3: The ibidi Heating System prevents condensation on the cell culture vessel lid, as well as on the Heated Lid itself.

4 Equipment

The Gas Incubation System is delivered with the complete set of cables and tubing needed for the operation of the system.

4.1 Components of the ibidi Gas Incubation System – Silver Line

An overview of the different ibidi Gas Incubation System – Silver Line versions is given in this section. Table 2 lists all available options of the ibidi Gas Incubation System – Silver Line and Table 3 shows all included components.

Table 2: Overview of the two versions of the ibidi Gas Incubation System – Silver Line

Cat. No.	Description	Components
11921	ibidi Gas Incubation System – Silver Line for CO ₂	Gas Mixer CO ₂ Humidifying Column Heated Tubing Package Gas Tubing for CO ₂ and Air USB cable Power cable USB flash drive
11923	ibidi Gas Incubation System – Silver Line for CO ₂ and O ₂	Gas Mixer CO ₂ /O ₂ Humidifying Column Heated Tubing Package Gas Tubing for CO ₂ and Air USB cable Power cable USB flash drive Gas Tubing for N ₂ Dead end tubing

Table 3: Overview of the components of the ibidi Gas Incubation System – Silver Line, CO₂/O₂ and ibidi Gas Incubation System – Silver Line, CO₂. The drawings are not to scale.







Component Name	Drawing
Gas Mixer	

Table 3: (continued)

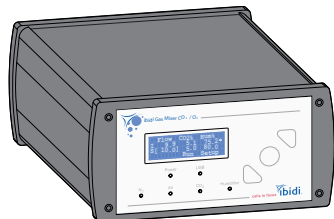
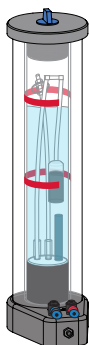
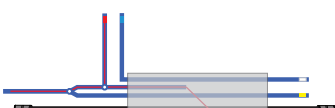
Component Name	Drawing
Humidifying Column	
Heated Tubing Package: cables and tubing to connect the gas outlet of the Gas Mixer, gas ports of the Humidifying Column and the gas inlet of the Heated Lid	
Gas tubing for CO ₂ , Air (and N ₂ *)	
Dead end tubing to close the N ₂ gas inlet*	
USB cable to connect the Gas Mixer with a computer	
External power supply for the Gas Mixer	
Country specific power cord to connect the external power supply to the wall socket	
USB flash drive with IncuControl software	

*Only for the CO₂/O₂ Version.

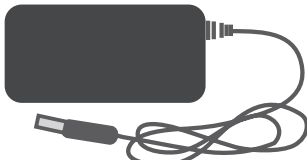
4.2 Gas Mixer CO₂ or CO₂/O₂

The Gas Mixer is the gas mixing and control unit of the Gas Incubation System. There are two versions of the Gas Mixer controlling either the amount of CO₂ or the amount of both CO₂ and O₂. Using the CO₂/O₂ version, hypoxia conditions can be created by replacing O₂ with nitrogen (N₂).

In addition to the gas mixture, the humidity within the incubation chamber is actively controlled by a feedback loop using a humidity sensor located in the incubation chamber. The humidity is increased by streaming the gas through a water column if the atmosphere is too dry.

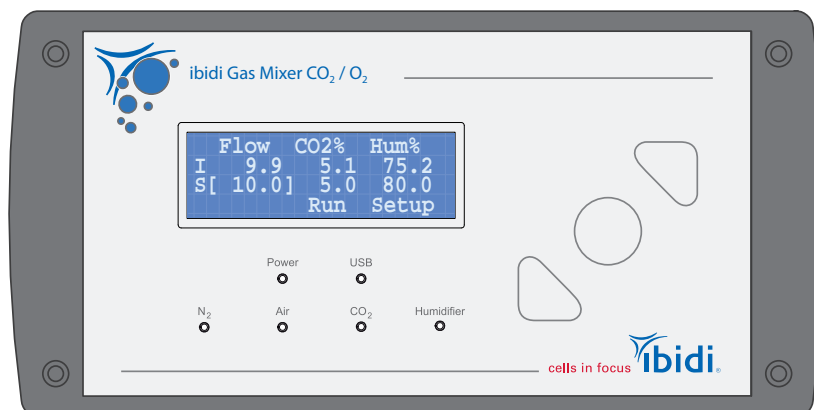

Figure 4: Front view of the Gas Mixer.

The LEDs on the front indicate the status of the channels: connection to the power supply, connection to the USB, gas control, and humidity control (Figure 4).

Table 4: Control LEDs of the Gas Mixer

LED Mode	Significance
LED off	Channel inactive
LED on	Channel active
LED Air/N ₂ /CO ₂ blinking	Input gas flow rate very high, please contact ibidi technical support if blinking persists
LED Humidifier blinking	Possible channel error, please contact ibidi technical support

On the back of the Gas Mixer, all connections for cables and tubing are provided (Figure 5). In the CO₂ version, the N₂ port is closed inside the instrument and thus non-functional.

The Gas Incubation System takes as input pure CO₂ gas and pressurized air, as well as pure N₂ gas (only Gas Mixer CO₂/O₂). Pressurized air can be supplied by the lab gas line or a small air pump or compressor. Purity information is given on page 8.

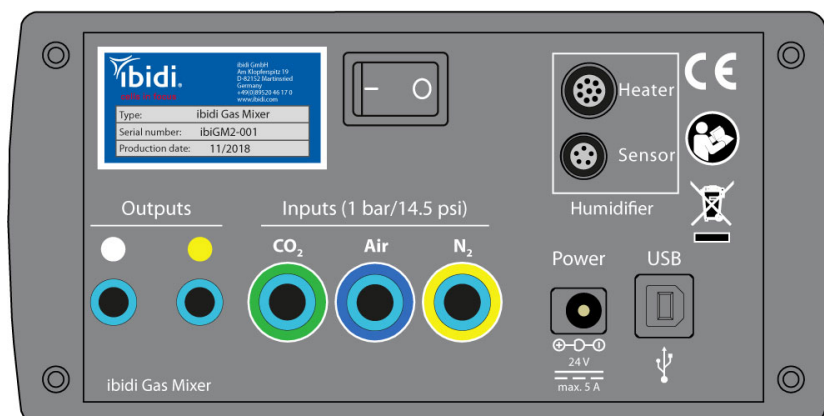

Figure 5: Back view of the Gas Mixer.

4.3 Humidifying Column

To avoid evaporation and drying out of the probe, the Humidifying Column humidifies the gas stream flowing into the incubation chamber. Part of the mixed gas output is guided through the column. The water inside the column is warmed up for higher humidity uptake. The different flow rates between the humidified and dry gas mixture control the humidity in the incubation chamber.

The Humidifying Column has two color-coded gas connections (input and output) as well as an electric plug for the heating of the column (connection see Section 5.1.2).

On top of the column is an opening for (re-)filling it with ultra-pure water (filling see Section 5.2). The maximum (~ 130 ml) and minimum (~ 50 ml) levels are indicated by the red labels inside the column (see Figure 6).



CAUTION – The Humidifying Column base heats up to 50°C/122°F when in operation.

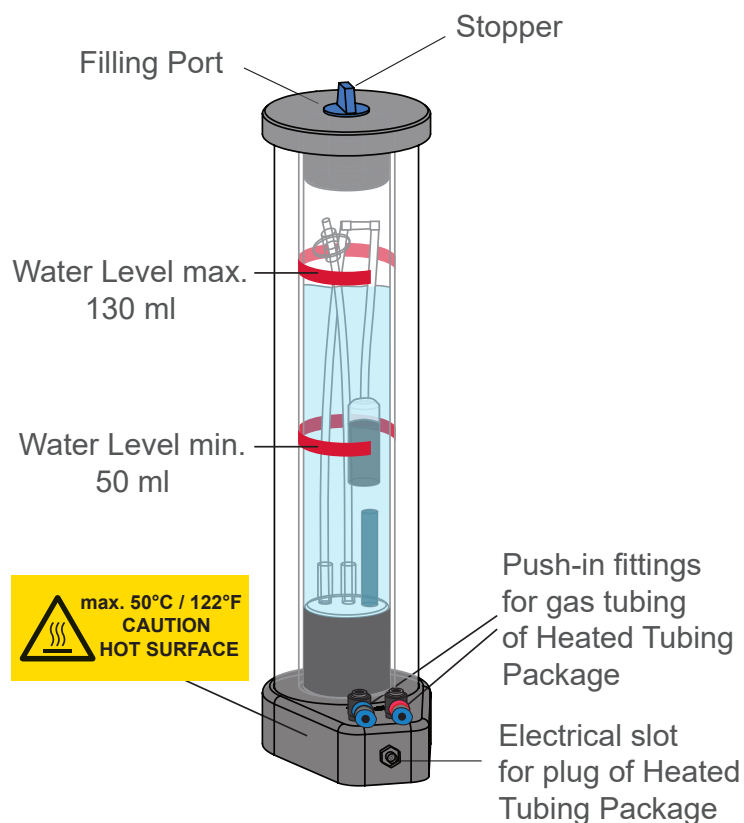

Figure 6: Humidifying Column.

4.4 Heated Tubing Package

The Heated Tubing Package connects the gas output of the Gas Mixer to the Humidifying Column and to the Incubation Chamber on the microscope stage (Figure 7). To actively control the humidity, two gas outputs are needed. One leads to the Humidifying Column and the other bypasses it. Both streams are combined in the tubing leading to the Incubation Chamber. By varying the flow rates of the two gas streams, relative to each other, the humidity is actively controlled (Figure 2).

The gas tubing carrying humidified gas is heated up to avoid condensation. For this purpose, a heating wire is inserted in the tubing. The wire is split off of the electrical cable under the insulating jacket enclosing the tubing. The exact connection of the tubing is shown in Figure 7.

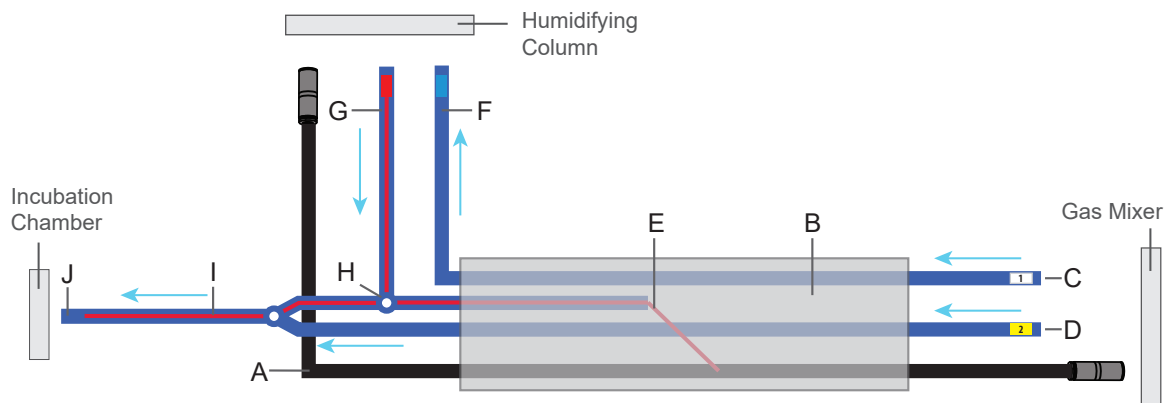

Figure 7: Heated Tubing Package: Electrical cable for the heating of the Humidifying Column (A), insulating jacket (B), Mixed gas output white and yellow (C and D), heated wire split off the electrical cable (E), gas input to Humidifying Column (F), gas output from Humidifying Column (G), merging point, where the heated wire is led into the tubing (H), gas tubing to the Incubation Chamber (I), gas tubing to push-in fittings of the Incubation Chamber Slide/Dish – Silver Line (J).



CAUTION – Do not cut the tubing leading to the incubation chamber! This would damage the heated wire in the inside and lead to malfunction.

4.5 Humidity Sensor

The humidity sensor measures the humidity inside the incubation chamber, enabling fast, active humidity control.

The ibidi Heating System Slide/Dish comes with the humidity sensor integrated in the Heated Lid of the Incubation Chamber (Figure 8).

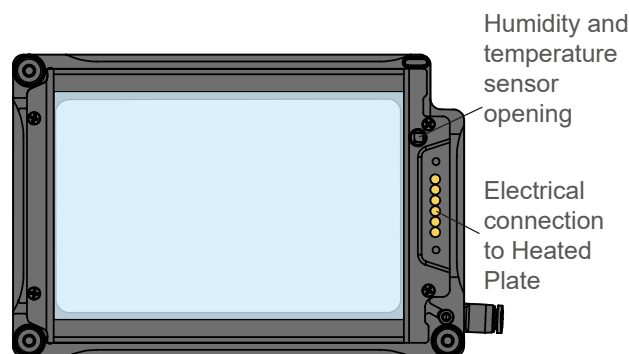

Figure 8: Humidity sensor integrated into the Heated Lid of the Incubation Chamber of the ibidi Heating System Slide/Dish.

The humidity sensor is integrated in a small cavity inside the Heated Lid. The humidity sensor is connected with the Heated Plate via the electrical connection pins of the Heated Lid. The cable of the Heated Plate guides the information of the humidity sensor to the Temperature Controller. For connection with the Gas Mixer an extra bridge cable is needed (see chapter 5.1.3).

Please note that when using an Incubation Chamber 4 Slides (product numbers 12130, 12131) or an Incubation Chamber Multiwell Plate (product numbers 12150, 12151, 12724, 12726), a different humidity sensor is in use. Please see the instruction manual version [“for use with the ibidi Heating System 4 Slides – Silver Line and ibidi Heating System Multiwell Plate – Silver Line”](#) for more information.

5 Operation

CAUTION – Before operating the gas mixer, the gas lines should be connected to the gas mixer controller and regulated to 1 bar/14.5 psi of pressure.

Under no circumstances any gas line should be connected, and pressure applied during operation of the gas mixer, as this will cause damage to the system.

After using the system, it is important to switch “off” the gas. That ensures all valve positions are set back to “closed”.

The procedure is explained in detail in the following sections.

5.1 Installation and Connection

Figure 9 shows an overview of how to setup the ibidi Gas Incubation System – Silver Line together with the ibidi Heating System Slide/Dish – Silver Line. The Gas Mixer and the Humidifying Column should be placed next to the microscope and on the same height level as the microscope stand. The tubing of the Heated Tubing Package needs to reach the Incubation Chamber on the microscope stage.

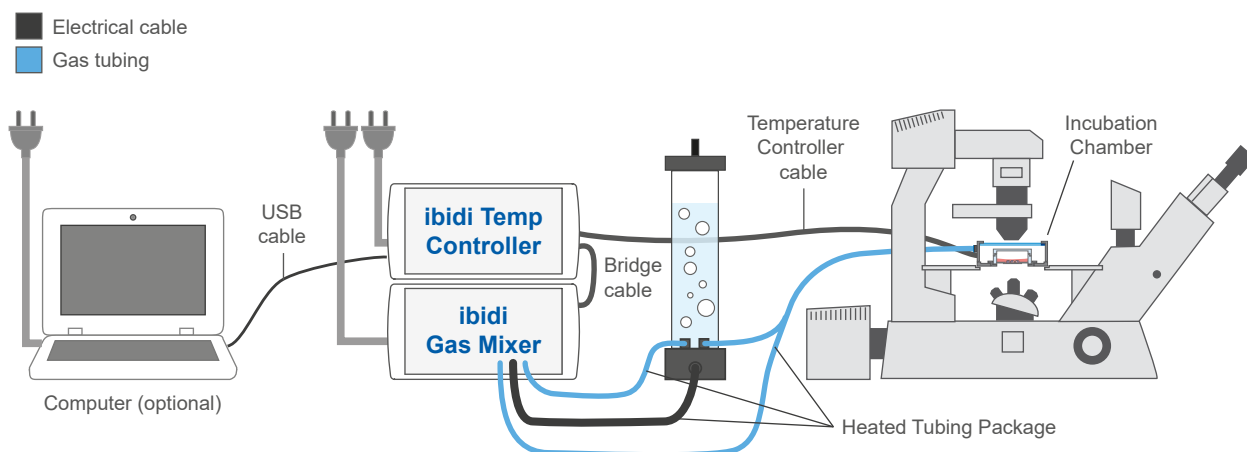

Figure 9: Connection of the components of the Gas Incubation System and the ibidi Heating System Slide/Dish – Silver Line.

CAUTION – Do not place the Gas Mixer and Humidifying Column on the microscope stage! The vibration might disturb the measurement.

To operate the Gas Incubation System, perform the following steps in the indicated order:

1. Place the Gas Mixer and Humidifying Column onto the microscope table next to the microscope.
2. Confirm that the power switch of the Gas Mixer is off (power switch is on the back of the Gas Mixer).
3. Connect the gas tubing from the gas supply to the back of the Gas Mixer (Section 11).
4. Connect the Heated Tubing Package (see Section 5.1.2).
5. Connect the humidity sensor cable, and the power supply (Section 5.1.3 and 5.1.4).

Figure 10 shows all connections of cables and tubing on the back of the Gas Mixer.

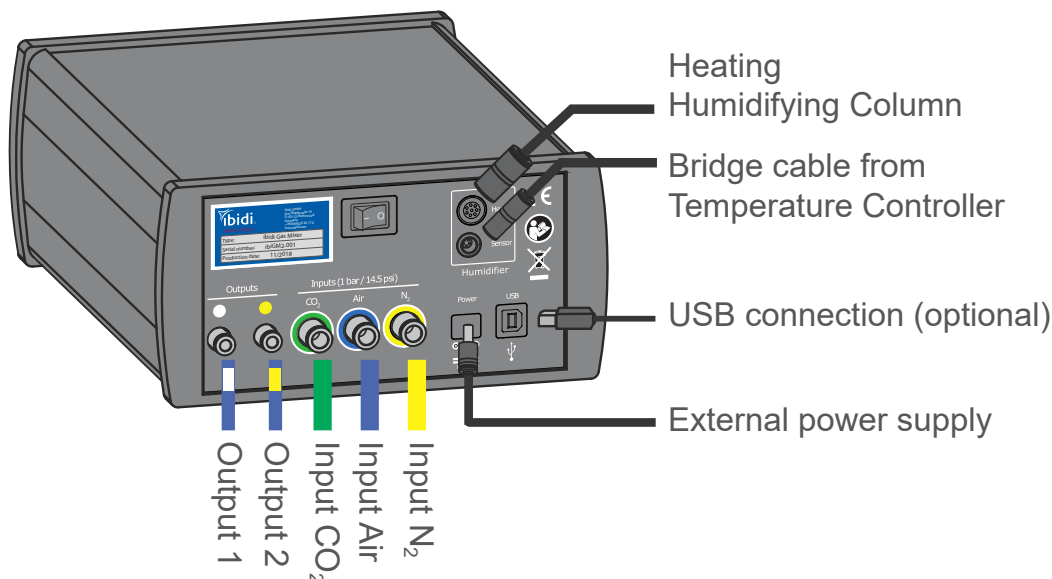

Figure 10: Overview of the connection of all cables and tubing to the Gas Mixer. In the CO₂ version the N₂ port is not available as closed by a seal.

5.1.1 Connection to the Gas Supply

The gases from the bottle or laboratory gas line need to be connected to the Gas Mixer with the OD 6 mm polyurethane tubing of the respective color. This tubing is delivered with the system.

Table 5: Available connections and color code in the two different Gas Mixer versions

Gas Input	Gas Pressure	Tubing Color
Air	1 bar/14.5 psi	blue
CO ₂	1 bar/14.5 psi	green
N ₂ *	1 bar/14.5 psi	yellow

*CO₂/O₂ version only

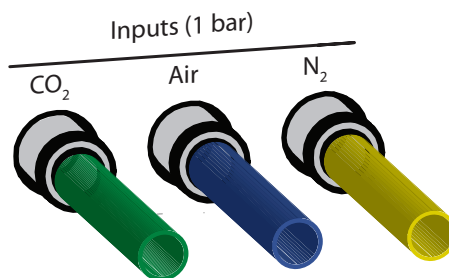

Figure 11: Connection of the gas tubing to the Gas Mixer. The N₂ port is closed and not available in the CO₂ version.

To connect the gas tubing to the Gas Mixer, push the tubing into the push-in fittings. The functional principle is shown in Figure 12.

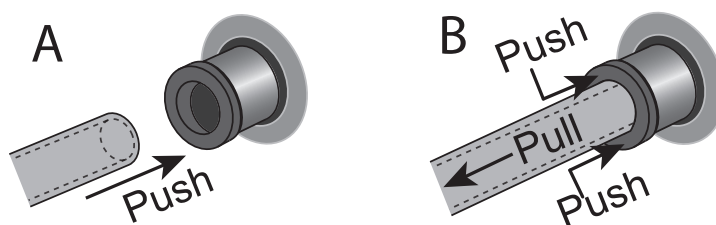

Figure 12: How to connect and disconnect the gas tubing to the push-in fittings. Push in to connect (A). Push and pull to disconnect (B).



CAUTION – Always connect all gas input ports with the appropriate gas (1 bar/14.5 psi). Do not leave any input ports open.
 CO₂/O₂ version: In case the N₂ input is not needed (CO₂/O₂ version only), close the N₂ input port using the provided dead-end tubing (Figure 13).

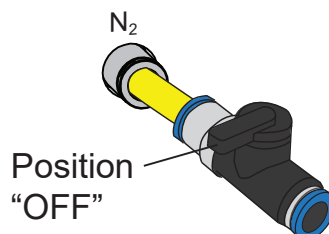

Figure 13: Close the N₂ port of the Gas Mixer with the dead end tubing if not needed (CO₂/O₂ version only).

To connect the gas tubing to the gas supply, we recommend using push-in fittings for polyurethane tubing with ID 4 mm/OD 6 mm. Push-in fittings suitable for your specific pressure reducing valve can be obtained from e.g. FESTO (Figure 14).

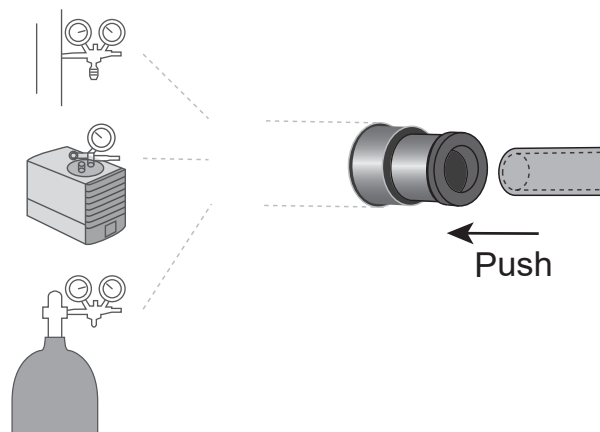

Figure 14: How to connect the gas tubing to a pressure reducing valve from a gas line, compressor, or gas bottle. A push-in fitting for 6 mm O.D. tubing is recommended.



WARNING – Only disconnect the tubing when there is no pressure on the gas line. First, switch off the pressure from the gas line. Control the remaining pressure on the gas line’s pressure reducing valve. Then, remove the tubing.

5.1.2 Connection of the Heated Tubing Package and the Humidifying Column

There are two lines coming from the Gas Mixer output. One goes to the Humidifying Column, the other directly to the Incubation Chamber.

Table 6: Connection of the gas lines with color code of the mixed gas

	Color Code
Gas Mixer output 1 (white)	Blue tubing with white label
Gas Mixer output 2 (yellow)	Blue tubing with yellow label
Humidifying Column output red	Blue tubing with red label
Humidifying Column output blue	Blue tubing with blue label

1. Connect the two gas outlets of the Gas Mixer to the white (1) and yellow (2) marked gas tubing to Output 1 and Output 2 on the back wall of the Gas Mixer.
2. Connect the plug of the electrical cable (next to the white and yellow gas tubing) to the “Heater” socket.
3. Connect the blue and red marked gas tubing to the respective inputs on the Humidifying Column.

4. To connect the electrical cable to the Humidifying Column, plug the cable into the connector on the column's base. Please make sure that the red dot on the cable and connector line up. Gently push to connect the plug.
5. To connect the mixed and humidified gas output to the Incubation Chamber push the open tubing into the push-in fitting of the Heated Lid of the Incubation Chamber.

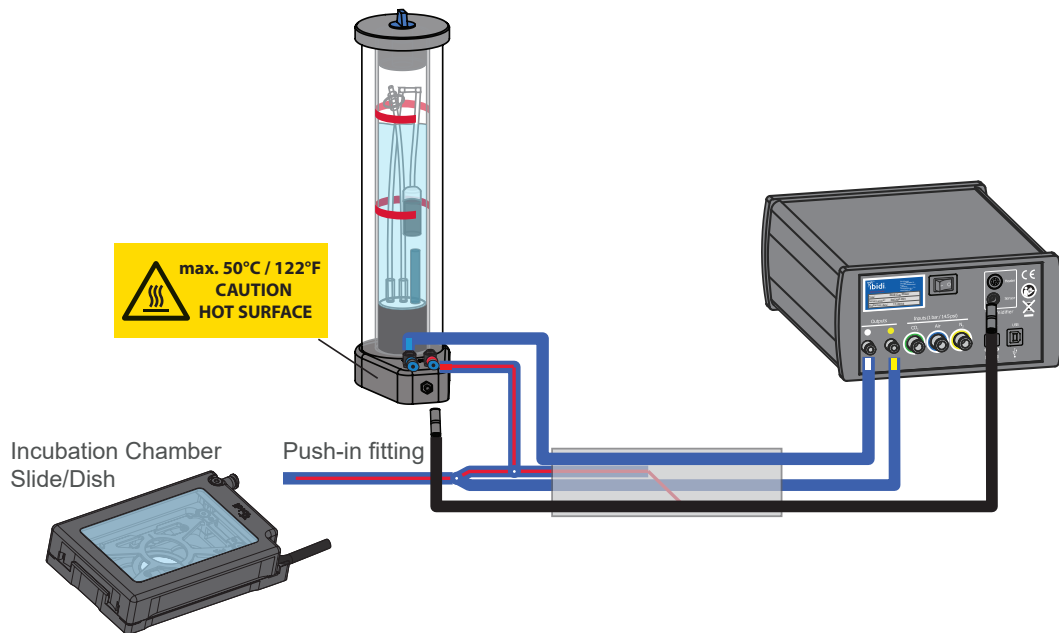

Figure 15: Connection of the Heated Tubing Package to the Gas Incubation System.

! **CAUTION** – Do not disconnect the Heated Tubing while the Gas Mixer is running. The resulting sudden change of pressure may lead to damage to the Gas Mixer. Be careful not to switch the red and blue inputs on the Humidifying Column, as this can also damage the gas mixer.

5.1.3 Connection of the Humidity Sensor

To operate the ibidi Gas Incubation System – Silver Line with humidity control, the information of the humidity sensor must be provided to the Gas Mixer.

The humidity sensor of the Incubation Chamber Slide/Dish – Silver Line is integrated in a small cavity inside the Heated Lid (Figure 8.) For connection with the Gas Mixer use the bridge cable (Figure 16).

1. Plug the cable of the Incubation Chamber for Slide/Dish into the Temperature Controller. Make sure that the red dots on the connectors of the cable and the slot line up and that the connector snaps into place (also applies to steps 2. and 3.).
2. Plug the bridge cable with one end to the "Signal Out" slot at the back of the Temperature Controller.
3. Plug the other end of the bridge cable to the "Sensor" slot at the back of the Gas Mixer.

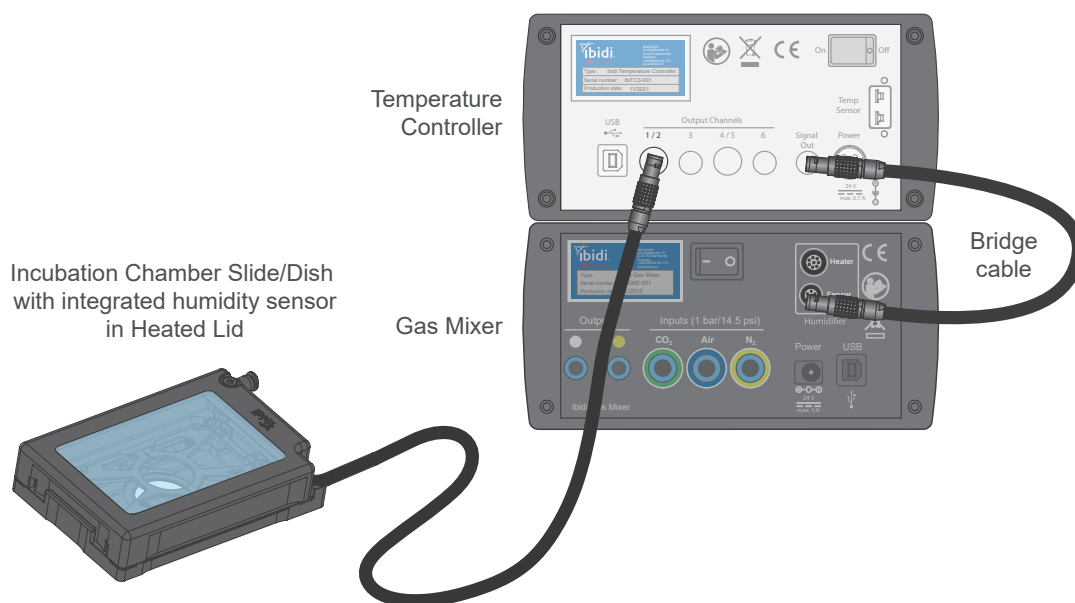

Figure 16: Connection of the internal humidity sensor via the bridge cable between Temperature Controller and Gas Mixer.

Please note, that when using an Incubation Chamber 4 Slides (product numbers 12130, 12131) or an Incubation Chamber Multiwell Plate (product numbers 12150, 12151, 12724, 12726), the connection of the humidity sensor to the Gas Mixer is not guided via the Temperature Controller and bridge cable, but via a separate humidity sensor cable. Please see the instruction manual version [“for use with the ibidi Heating System 4 Slides – Silver Line and ibidi Heating System Multiwell Plate – Silver Line”](#) for more information.

5.1.4 Connection of the Power Supply (and USB optionally)

To finish the setup, the power supply must be connected. Optionally, the USB cable can be used to connect the Gas Mixer to an external computer. This enables the use of the IncuControl software delivered with the system (Section 6) for data logging and control of the parameters of the experiment.

1. Plug the power supply into the connector on the Gas Mixer labeled "Power".
2. Connect the other end to the wall socket.
3. Optional: Connect the computer to the Gas Mixer with the supplied USB cable.

5.2 (Re)-Filling the Humidifying Column

Before the first use, the Humidifying Column must be filled with 130 ml of ultra-pure water. During operation, the column should always be refilled before the water level falls below the minimum mark.

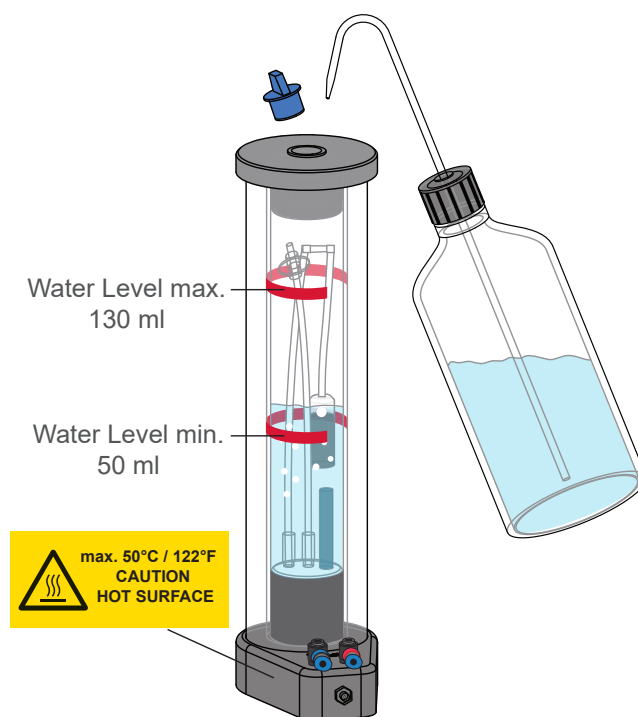

Figure 17: (Re)-Filling the Humidifying Column.

Open the blue stopper on top of the column and use a wash bottle to fill it with ultra-pure water. The water level must be in between the minimum and maximum mark (Figure 17).

The re-filling of the Humidifying column can be done during operation, without stopping the Gas Mixer. Note that re-filling the column during operation may lead to a temporary drop in the chamber's humidity.

The length of intervals between refillings depends on set points of the humidity and flow on the Gas Mixer.



CAUTION – Always close the filling port tightly to prevent gas leakage and malfunction of the system!



WARNING – Never disassemble the column while it is plugged into the Gas Mixer or when still hot after it has been in use. The heating element in the column can cause serious burns.

5.3 Switching on the System

After connecting all cables and tubing, and after filling the Humidifying Column with ultra-pure water, the system is ready to start.

1. Set your gas regulation valve to the recommended pressure of 1 bar (14.5 psi).
2. Switch on the Gas Mixer and wait for "self test" (all systems) and "heat up" (only CO₂/O₂ versions).
3. Set the parameters on the display (Section 5.4).
4. Check that the display shows "Run" (see Section 19).
5. Let the system equilibrate all parameters for a minimum of 30 minutes.



NOTE – Immediately after powering up, the Gas Mixer runs a flow sensor calibration routine for several seconds. The display shows "self test".

After this, the Gas Mixer for CO₂/O₂ will automatically start a warm-up routine for 5 minutes. The display shows a blinking "heat up". After 5 minutes, the device will begin normal operation. The CO₂ version is ready for operation immediately after the "self test".

For most applications, we recommend using the values given in Table 7. The full specification range is indicated in the specifications (Section 1.4).



CAUTION – Be aware that when the system is switched on, some parts of the tubing are actively heated: The Humidifying Column base (max. 55°C/131°F), the water in the Humidifying Column (max. 60°C/140°F) and the Heated Tubing Package (max. 50°C/122°F outside).

5.4 Setting Parameters with the Front Display

All control parameters can be manually set on the controller using the buttons and the display on the front panel.

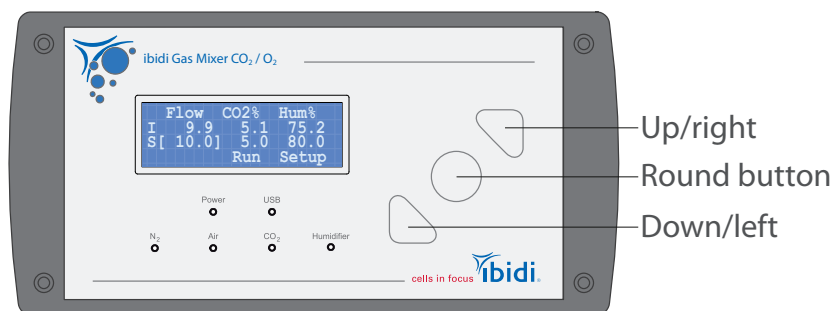

Figure 18: Gas Mixer front display and set buttons.

The display shows the measured ('I' = instantaneous) and set ('S' = set) temperatures of all the channels.

The cursor position is indicated with square brackets ("[" "]"). You can move the cursor using the "left" and "right" buttons. If you want to select a parameter or a function, press the round button and the square brackets will change to angle brackets ("<" ">"). Now you are able to change the value with the "up" and "down" buttons. To confirm the changed value, you must press the round button once more.

5.4.1 Run/Stop Mode

Set the whole system to run or stop mode by manipulating the setting in the display's bottom line to "Run" (= system is running) or "Stop" (= system is not running).

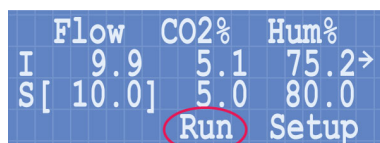

Figure 19: Main display indicating "Run".

5.4.2 Incubation Parameters

Table 7: Recommended parameters for the operation of the ibidi Gas Incubation System – Silver Line

Parameter	Recommended Values
CO ₂ (%)	5–10% depending on buffer
O ₂ * (%)	20% (see Figure 20)
Humidity (%)	90–95%
Flow rate	10 l/h
Column temperature (°C)	50°C

*for CO₂/O₂ version only

CO₂ regulation CO₂ is standardly set to 5% in cell culture experiments.

Humidity regulation Humidity values at the lower end of the control range can only be achieved using dried compressed air or with a compressed air pump in a very dry environment. The exact value of the lower limit will vary depending on the amount of water vapor present in the input gases used, the pressure, and the temperature of the measured environment.

Flow rate At flow rates below 7 l/h, gas mixes may not reach the highest possible humidity. If this is the case, augment the gas flow rate until the humidity is reached.

O₂ regulation/hypoxia (Gas Mixer for CO₂ and O₂ only) To generate hypoxia conditions, set the oxygen to the target value. The O₂ will be replaced by nitrogen (N₂) until the set value is reached.

Please keep in mind that in a CO₂/air mixture, the O₂ concentration will drop when the CO₂ concentration is raised. The maximum oxygen concentration thus decreases according to the CO₂ value you have chosen. Please see the graphic below for estimating the maximum O₂ concentration in your gas mix for a set CO₂ concentration. For example, when setting the CO₂ concentration to the common value of 5%, the maximum oxygen level is decreased to 20% O₂ (see Figure 20).

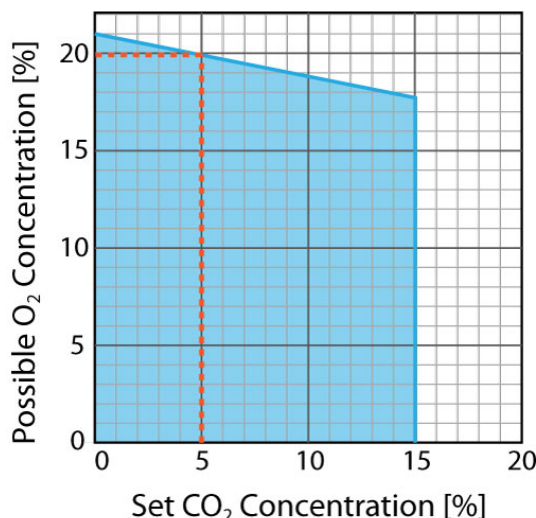

Figure 20: Maximum O₂ concentrations at different CO₂ concentrations in gas mixtures from the Gas Mixer.

5.4.3 Setup Menu

The Setup menu offers the possibility to change the settings of the individual channels and the display. Please note that for standard operation, no changes need to be made. Enter the setup menu by navigating to the “Setup” entry and pressing the round button. The mode dialog will open.

Mode Each channel of the Gas Mixer can be set to an “On” or “Off” state. For standard operation all channels must be turned on. Only if you use the CO₂/O₂ version without nitrogen (N₂) connection, it is recommended to turn the O₂ channel off. In this case make sure that the dead-end tubing is attached to the N₂ port and closed.

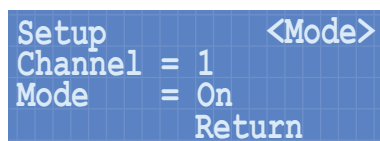

Figure 21: Mode dialog.

1. Press the round button once more to move the cursor to the channel number.
2. Select the respective channel and confirm with the round button.
3. Select “On” or “Off” and confirm with the round button.
4. To move on navigate to “Return” and press the round button.

Table 8: Channel numbers are dedicated as follows:

Channel number	Parameter
Channel 1	Flow (outlet gas flow rate)
Channel 2	CO ₂
Channel 3	Humidity
Channel 4	T-C (Humidifying Column Temperature)
Channel 5	O ₂ *

*CO₂/O₂ version only

Alarms In this dialog it is possible to set the alarm limits for divergent control parameters. Move from the mode menu to the alarm menu by pressing the "right" button.

The maximum and minimum limits of the alarm can be set for each individual channel. If the alarm is activated (which happens when the current value goes under/over the low/high limits), the current value (I) blinks, showing alternately the value and "low" or "high", respectively. To stop the display blinking, navigate to the blinking channel and press the round button once.

```

Setup      <Alarms>
Channel = 4
High      = 42°C
Low       = 36°C
    
```

Figure 22: Alarm settings dialog.

Preferences Set the brightness and contrast of the display in the preferences menu.

```

Setup <Preferences>
Backlight = 65
Contrast  = 15
          Return
    
```

Figure 23: Preferences dialog.

Info Information about serial number and firmware version is shown in the info dialog.

```

Setup      <Info>
2
SN: ibiGM2-001
FW 2.11.02
    
```

Figure 24: Info display.

6 IncuControl Software

The Gas Mixer has a USB interface for computer control and data logging. For this purpose, ibidi provides the IncuControl software that comes with the controller or can be downloaded from the [ibidi website](#).

For more details, please refer to the [IncuControl instructions](#).

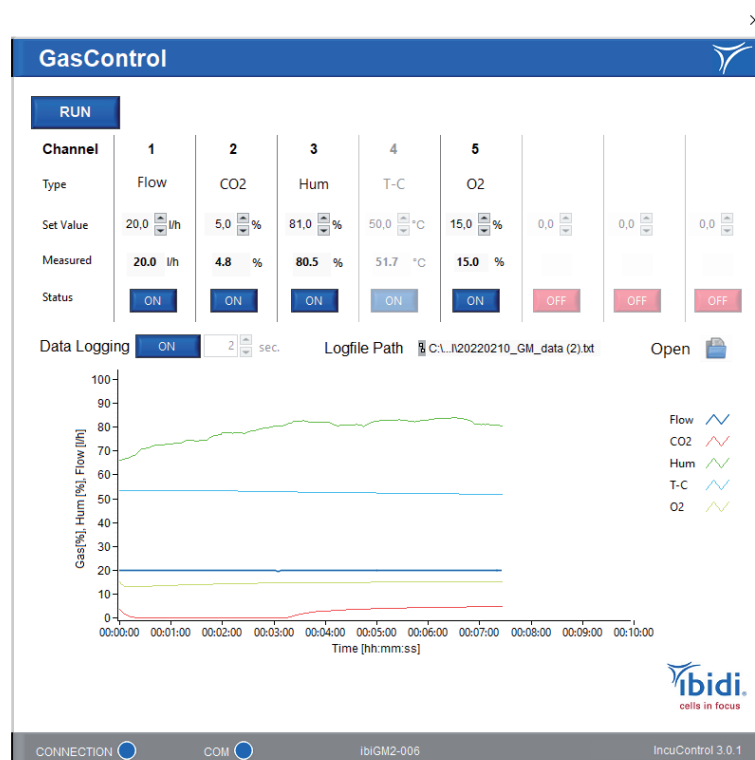

Figure 25: Gas Mixer control window in IncuControl.

Prohibitions on the use of ibidi software:

The following actions are prohibited:

- Copying software for other than backup purposes
- Transferring or licensing of the right to use software to a third party
- Disclosure of confidential information regarding software
- Modification of software

7 Maintenance

7.1 Disinfection and Cleaning

7.1.1 Wiping the Outer Surface

To clean the Gas Mixer and Humidifying Column from the outside, switch off the Gas Mixer and disconnect all cables and tubing. Leave the instrument to cool down for approximately 5 minutes. Use only dry cloth or a cloth dampened with water (ultrapure) or common lab disinfection solutions that are based on quaternary ammonium compounds (e.g., Barrycidal 36 or Pharmacidal). Fingerprints can be removed using ethanol or isopropanol (70%) or lens/eyeglass cleaning wipes.



CAUTION – 70% ethanol or isopropanol can be used to wipe the Humidifying Column from the outside. Do not use any other organic solvents. Do not expose to ethanol or isopropanol for an extended period of time. It can lead to damage of the Humidifying Column.

7.1.2 Cleaning the Column's Inner Face

Microbial contamination in the Humidifying Column is usually not a problem since distilled water and light-starved environments (microscopy rooms) do not support microbe growth. If, however, contamination has occurred, disinfect the Humidifying Column by running the system with 3% hydrogen peroxide for 1 hour. Subsequently wash with water. The use of anti-microbial agents is not recommended since they can be transported as aerosols and end up in the specimen.

7.2 Influence of Surrounding Temperature and Airflow

The surrounding, ambient temperature affects the temperature inside the microscopy chambers. Devices, such as computers and camera controllers, can significantly heat up small rooms. In this case, we recommend equilibrating the room temperature to the typical experimental conditions at least 2–3 hours before starting the experiment.

Airflow can enhance the effect of temperature and humidity changes in the vicinity of the Incubation Chamber. In cases where airflow (e.g., air conditioning) cannot be stopped, we recommend protecting the microscope as much as possible from it.

8 Troubleshooting

8.1 Controller Display Errors

Error Description	Possible Cause	Possible Solution
The display does not work, although the power supply is connected.	Power supply interrupted.	Check the power supply module and the wire.
	ON/OFF switch of gas mixer off.	Switch on gas mixer.
The humidity channel displays “N.C.” (Not Connected) in the device display or IncuControl set up.	Incubation Chamber with internal humidity sensor not connected (Figure 8).	Connect the Incubation Chamber as shown in Figure 16.
Humidifying Column channel displays “N.C.” (Not Connected) in the device display or IncuControl set up	Humidifying Column not connected.	Connect the Humidifying Column.
O ₂ channel reads “N.C.” (Not Connected) in the IncuControl software or does not appear on the device display.	Gas mixer for CO ₂ only.	Make sure the Gas Mixer is a CO ₂ /O ₂ mixer. CO ₂ only mixers do not have an O ₂ channel.
The CO ₂ or O ₂ gas channel displays large negative values or the error message “SHORT” is displayed.		Contact ibidi technical support .

8.2 Flow Readings

Error Description	Possible Cause	Possible Solution
Gas flow reading is “0”.	Gas supply lines are not opened.	Open gas lines.
	Gas supply lines are not connected correctly.	Inspect all gas supply lines connection points to ensure they are connected securely and correctly.
	Connected gas cylinder is empty or not opened.	Open or replace the gas cylinder.
	Insufficient gas pressure.	Set every gas pressure to 1 bar (14.5 psi).
	Device or gas supply channels are set “STOP” or “OFF”.	Set “RUN” (Figure 19) or “ON” (Figure 21) using the controller display or IncuControl software.

(Table continued)

	The N ₂ gas line valve is open but not in use and not connected to N ₂ gas supply (unit with CO ₂ /O ₂ control only).	Close the N ₂ gas supply line (dead end tubing) and set the O ₂ channel to "OFF" on the controller display or IncuControl if the O ₂ control is not in use.
	Defective flow sensor or valve.	Check if gas bubbles form inside the Humidifying Column. Contact ibidi technical support .
Gas flow reading is unstable or consistently at incorrect value.	Incorrect set values.	Please check set values of flow, CO ₂ (and O ₂). Flow can be unstable when set values are incorrect.
	Gas supply pressure too low or high.	Set gas line pressure to 1 bar (14.5 psi).
	The N ₂ gas line valve is open but not in use and not connected to N ₂ gas supply (unit with CO ₂ /O ₂ control only).	Close the N ₂ gas supply line (dead end tubing) and set the O ₂ channel "OFF" on the device display or IncuControl software.
	Defective valve or flow sensor.	Turn off the gas mixer and check if gas is still flowing through the Humidifying Column (appearance of gas bubbles inside). If gas is still flowing inside the Humidifying Column, the valve is defective. Contact ibidi technical support .
	Gas line restriction.	Make sure that the gas lines are not blocked or kinked. Please note: The system must be restarted after the restriction is removed.
	Humidifying Column is not closed properly.	Make sure that the Humidifying Column is properly sealed with the blue silicone plug.

8.3 CO₂ Channel Readings

Error Description	Possible Cause	Possible Solution
CO ₂ channel shows "0".	CO ₂ gas supply line is closed.	Open gas lines.
	CO ₂ gas supply line is not connected correctly.	Inspect CO ₂ gas line to ensure gas supply line is connected securely and correctly.
	Connected CO ₂ gas cylinder is empty or not opened.	Open or replace the gas cylinder.

(Table continued)

CO ₂ Gas flow reading is unstable, oscillating or does not reach set value. ¹	CO ₂ Gas supply line is not connected correctly.	Inspect CO ₂ gas line to ensure gas supply line is connected securely and correctly.
	Insufficient CO ₂ gas pressure.	Set CO ₂ gas pressure to 1 bar (14.5 psi).
	Gas line restriction.	Make sure that the gas lines are not blocked or kinked. Please note: The system must be restarted after the interruption is removed.
	The N ₂ gas line valve is open but not in use and not connected to N ₂ gas supply (unit with O ₂ control only).	If the O ₂ channel is not in use, close the N ₂ gas supply line (dead end tubing) and set the O ₂ channel to "OFF" on the device display or In-cuControl.
	The O ₂ concentration is set too high.	Make sure the ratio of O ₂ /CO ₂ concentration is set correctly. ²
The CO ₂ level overshoots the set point considerably.	Defective valve or flow sensor.	Contact ibidi technical support .
CO ₂ regulation is very slow.	CO ₂ level has not reached the set value. ²	Let CO ₂ level adjust for 15 minutes.
	CO ₂ The channel has been turned "ON" just after it was "OFF" for a while.	It will take up to 10 minutes for the CO ₂ level to reach the adjusted set point. ³

8.4 O₂ Channel Readings

Error Description	Possible Cause	Possible Solution
O ₂ channel shows "0".	Dead end tubing of the N ₂ Gas supply channel is closed.	Open the dead-end tubing for the N ₂ gas supply.
	N ₂ Gas supply line is not opened.	Open the N ₂ gas line.
	N ₂ Gas supply line is not connected correctly.	Inspect N ₂ gas line to ensure gas supply line is connected securely and correctly.

¹Also see "Gas flow reading is unstable or consistently at incorrect value"

²Please note that it can take up to 5 minutes until the set CO₂ concentration is reached

³The gas mixer must not be switched off for a CO₂ concentration of ambient air (appr. 0,04%). Please set the CO₂ value in the gas mixer at 0% to reach a CO₂ concentration of ambient air.

(Table continued)

	Connected gas cylinder is empty or not opened.	Open or replace the gas cylinder.
O ₂ Gas flow reading is unstable, oscillating or does not reach set value. ⁴	N ₂ Gas supply line is not connected correctly.	Correctly connect the N ₂ gas supply line.
	Insufficient N ₂ gas pressure.	Set N ₂ gas pressure at 1 bar (14,5 psi).
	The CO ₂ /O ₂ concentrations are set at incorrect values.	Make sure the ratio of CO ₂ /O ₂ concentration is set correctly. ⁵
	Gas line restriction.	Make sure that the gas lines are not blocked or kinked. Please note: The system must be restarted after the interruption is removed.
	The concentration of O ₂ is set to 20% or higher.	Make sure the ratio of CO ₂ /O ₂ concentration is set correctly. ⁵

Please make sure the set values are set to ambient air values (0% CO₂, 21% O₂) in case the corresponding gas is not connected. Additionally, keep in mind that the maximum O₂ concentration depends on the set CO₂ concentration. See chapter 5.4.2 for further details.

8.5 Humidity Channel Readings

Error Description	Possible Cause	Possible Solution
Humidity channel reading is “0”.	Humidity sensor not connected.	Connect the Incubation Chamber as shown in Figure 16.
	Condensation on the humidity sensor.	Open and turn around the Heated Lid (Figure 8), remove water with a lint free tissue and allow the sensor to dry. If set humidity is close to 100%, reduce set value by about 5–10%.
	Defect humidity sensor.	Blow exhaled air directly on the sensor. You should see an increase of humidity. If the humidity sensor is not giving readings, it is likely defective. Contact ibidi technical support .
The humidity does not reach set value.	Incubation Chamber open or not closed properly.	Make sure the Incubation Chamber is closed properly.

⁴Also see “Gas flow reading is unstable or consistently at incorrect value”

⁵See Figure 20

(Table continued)

	Temperature inside the Incubation Chamber is significantly warmer than 37°C (e.g., 40°C+).	The temperature inside the Incubation Chamber must be approximately 37°C to reach humidity values of 90% or higher.
	Heated Tubing Package not connected properly.	Connect the Heated Tubing Package to the Humidifying Column and Gas Mixer. Inspect all Heated Tubing Package connections to ensure parts are connected properly.
	Condensation inside the Heated Tubing Package.	Disconnect the Heated Tubing Package and shake the water out. Reconnect the Heated Tubing Package, set the humidity to 0%, and run the system for 30 minutes to allow the Heated Tubing Package to dry completely.
	Defective Heated Tubing Package.	Check by touch if the Heated Tubing Package is warmed up. If not, contact ibidi technical support .
	Heated Tubing package is damaged and gas escapes.	Check if any damage to the Heated Tubing Package is seen. Contact ibidi technical support .
	Humidifying Column not closed properly.	Make sure that the column is properly sealed with the blue silicone plug.
	Defective Humidifying Column.	Check if the Humidifying Column is heating up and measure the temperature of the water inside the Humidifying Column (set-point temperature must be 45–50°C). Check IncuControl or the display to see if the set temperature is reached. Contact ibidi technical support .
Humidity level is significantly below set value (> 10%).	No flow or incorrect flow values.	Make sure flow reads the set point. Please also check for possible causes under "humidity does not reach set value".
	Condensation on the humidity sensor.	Open and turn around the Heated Lid (Figure 8), remove water with a lint free tissue and allow the sensor to dry. If set humidity is close to 100%, reduce set value by about 5–10%.
Humidity stays at a constant level.	Condensation on the humidity sensor.	Open and turn around the Heated Lid (Figure 8), remove water with a lint free tissue and allow the sensor to dry. If set humidity is close to 100%, reduce set value by about 5–10%.

(Table continued)

Defective humidity sensor.	Blow exhaled air directly on the sensor. You should see an increase of humidity. If the humidity sensor is not giving readings, it is likely defective. Contact ibidi technical support .
----------------------------	---

8.6 Humidifying Column

Error Description	Possible Cause	Possible Solution
Gas is not running through the Humidifying Column (no gas bubbles).	If the humidity value is close to or at the set point, gas will stop flowing through the Humidifying Column.	Let flow reach the set point. If flow is stable at set point no bubbles form.
Gas bubbles form in the Humidifying Column even when all valves are shut or the device is turned off.	Defective valve.	Contact ibidi technical support .

Please also see chapter 8.5. Contact [ibidi technical support](#) for further troubleshooting support.

8.7 Focus not Stable

Focus drift is detrimental for most microscopy experiments, especially long duration time-lapse experiments. Focus stability is mainly influenced by mechanical changes and temperature variations. Follow these recommendations to keep your cells in focus:

- Switch on all components (e.g., heating, gas incubation, computer, or other equipment) at least 60 minutes before starting the experiment.
- After you put the sample onto the microscope, wait 30 minutes before starting a time-lapse experiment to achieve temperature and immersion oil equilibration⁶.
- Keep the room temperature as stable as possible. Air conditioning should either be working continuously or switched off.
- Do not change the temperature during the experiments. Avoid door/window openings, as this could rapidly change the temperature.
- Eliminate all sources of mechanical vibrations. Use a damped table for your microscope.

⁶If the experiment needs to be started immediately, either after placing the sample on the microscope or after closing the lid, we recommend checking the focus for 20 minutes. In the first few minutes after starting the experiment, temperature equilibration might influence the focus/z-position of the cells.

8.8 Evaporation is Too High

Depending on the incubating conditions, small volumes might evaporate quickly, especially during long-term experiments. If you have an actively controlled humidifying device (e.g. ibidi Gas Incubation System), increase the set value for humidity. Additionally, we suggest using silicone oil (e.g. Anti-Evaporation Oil, ibidi, 50051) to decrease evaporation.

Covering the medium with sterile silicone oil prevents all evaporation effects and is compatible with cell culture. Please do not use mineral oil, as this can be harmful to your cultureware.

Equilibrate oil and medium inside the incubator overnight. This step helps to avoid the formation of air bubbles, and pre-warms the solutions to 37°C. Afterwards, fill your slide with cells and medium. Cover the medium's surface with an appropriate amount of silicone oil. Don't drip the oil directly onto the surface, but let it run down the edges of the cell culture vessel. Details about avoiding evaporation are given on the ibidi web site in [Application Note 12 "Avoiding Evaporation"](#).

8.9 Condensation Inside the Stage Top Incubator

Check the temperature of the Incubation Chamber. Make sure the humidity sensor is not in contact with the Heated Lid. In case of condensation, decrease the humidity and air-dry the incubator if necessary.

Please contact ibidi at techsupport@ibidi.com for further troubleshooting help.



ibidi GmbH

Lochhamer Schlag 11
82166 Gräfelfing
Germany

Toll free within Germany:

Phone: 0800/00 11 11 28
Fax: 0800/00 11 11 29

International calls:

Phone: +49 89/520 46 17 - 0
Fax: +49 89/520 46 17 - 59

E-Mail: info@ibidi.com
ibidi.com

