

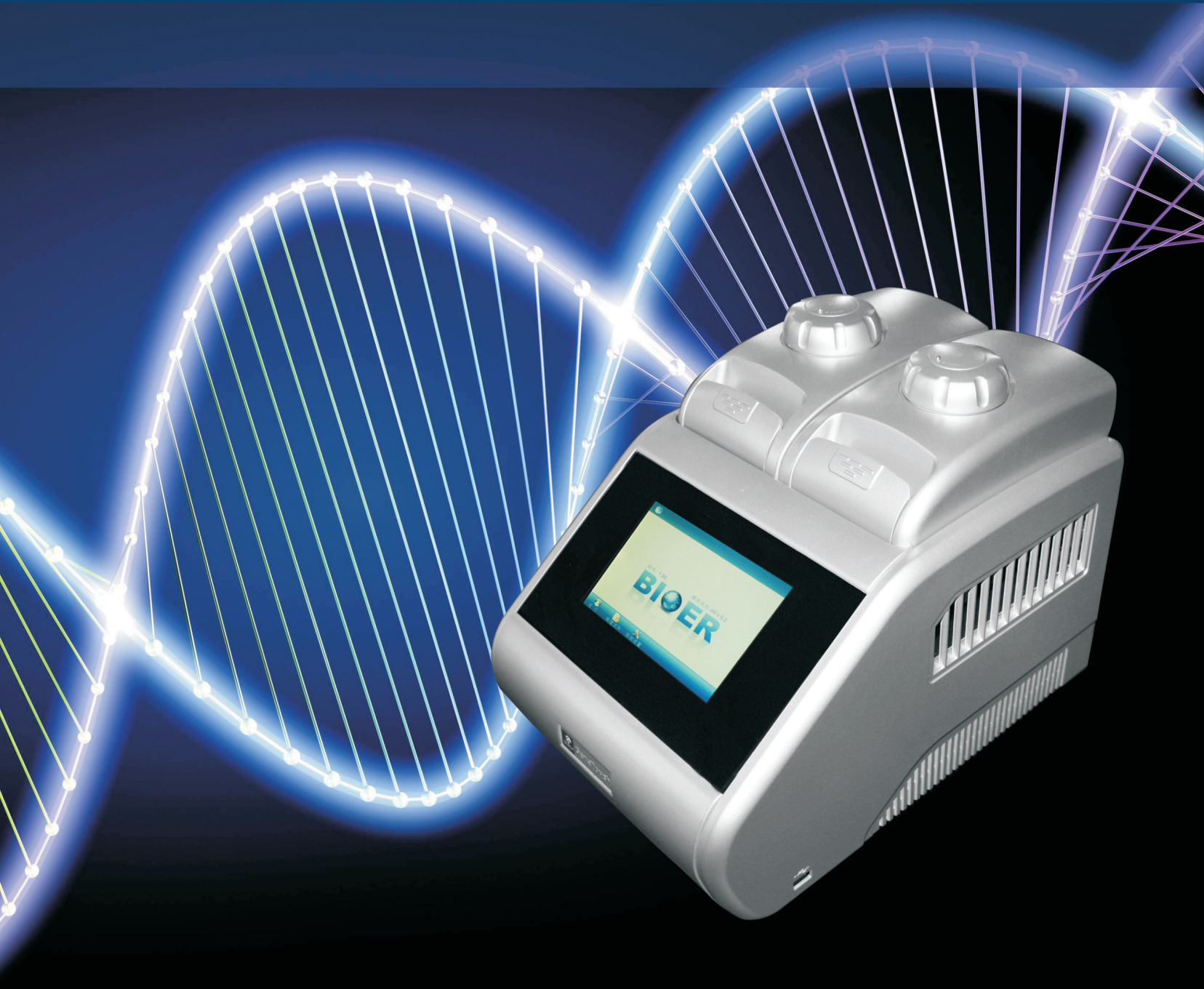

BIOER
TECHNOLOGY

GeneTouch Thermal Cycler

INSTRUCTION MANUAL



Caution:

The Bioer Co. reserves the right to modify this manual at any time without notice.

The manual contains copyright protected and patented material. Without prior written consent from Hangzhou Bioer Technology Co., Ltd., any part of the manual shall not be duplicated, reproduced or translated into any other language.

Before initial use of this instrument, please carefully read this manual!

Product Patent No.: ZL 20092019972313

Product Standard No.: YZB/ Z 0189-2010

The product is for scientific research only

Document No.: BYQ661500000000ESM

Document Version: January 2016, Version 1

IMPORTANT NOTES

1. General Practice

Caution: Important information is contained in any item and should be carefully read. Failure to observe the instruction would result in damage or abnormal functions to instrument.

Warning! The warning message requires extremely careful operation of a certain step. Failure to observe the instruction would result in serious personal injury.

2. Safety

During operation, maintenance and repairment on this instrument, the following basic safety notes shall be observed. In case of failure to follow these measures or the warnings or notes indicated herein, the basic protection provided by the instrument, its safety criteria of design and manufacture, and its predicted use range would be impaired.

Hangzhou Bioer Technology Co., Ltd. shall be irresponsible for the consequence resulted from user's failure to observe the following requirements.

Caution: This instrument conforms to Class I and Protection Class IP20 of GB4793.1 Standard and it is for indoor use.
 ① This product has been tested to the requirements of CAN/CSA-C22.2 No. 61010-1, second edition, including Amendment 1, or a later version of the same standard incorporating the same level of testing requirements.

a) Instrument earth

In order to avoid electrical shock accident, the input power wire of instrument shall be reliably earthed. This instrument uses 3-core earth plug and this plug is provided with a third (earth) leg, is merely used for earth type power socket and is a safety unit. If the plug is impossible to insert into the socket, the socket shall be correctly fixed by electrician; otherwise, the earth plug would lose safe protection function.

b) Keeping apart from the live circuit

The operator shall not disassemble instrument without permission. Only qualified professionals are allowed to replace elements or adjust the machine inside. Replacement of elements under energizing state shall be prohibited.

c) Use of power supply

Before turning on AC power, make the power voltage consistent with the instrument-required one (a $\pm 10\%$ deviation is allowed). Make the rated load for power socket not below instrument's maximum load.

d) Power wire

Generally, this instrument uses accompanied power wire. The damaged power wire shall be replaced by one power wire of the same type and the same specification. It can't be repaired. The power wire shall neither be compressed nor be laid in gathered personnel location.

e) Insertion and withdrawal of power wire

At insertion and withdrawal of power wire, the plug shall be correctly held with hand. At insertion, the plug shall be completely and tightly inserted into the socket and at withdrawal heavily pulling the wire shall not be allowed.

f) Placement of instrument

This instrument shall be fixed in a low RH and low dust place apart from water source (e.g. water pool and water pipeline) and the room shall be well ventilated, and free from corrosive gas and interference of strong magnetic field. The instrument shall not be placed in a wet or dusty location.

The openings on this instrument are for ventilation circulation and in order to avoid over-heat of the instrument body they shall not be blocked or covered. When a single set or several sets of instrument are used, the interval between its surrounding ventilation opening and its nearest object shall not be below 50cm or 100cm. Also, don't use the instrument on loose or soft surface, or the air inlet at instrument bottom might be blocked.

Excessive temperature would impair the test performance or result in instrument failure. This instrument shall not be used in location subjected to direct sunshine. The instrument shall be kept away from hot gas, stove and all other heat source.

If the instrument is to be set aside for a long time, the power plug shall be withdrawn and the instrument covered with soft cloth or plastic film to avoid entrance from dust.

g) Cautions during operation

During test, cares shall be taken to prevent liquid from dropping onto the instrument.

Caution: In any of the following cases, immediately cut off the power supply, withdraw the power plug from the power socket, contact the supplier or ask qualified repairman for treatment:

- ⊙ Liquid drops into inside of the instrument.
- ⊙ The instrument is rained or watered.
- ⊙ The instrument works abnormally, especially generates abnormal sound or odor.
- ⊙ The instrument is dropped or its casing is damaged.
- ⊙ The function of instrument is obviously changed.

3. Instrument label

a) Label

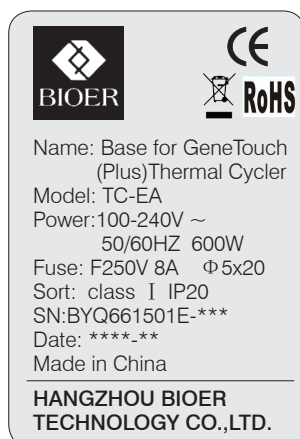

b) Warning Sign



Warning!

The instrument is adhered with mark "HOT SURFACE!" During operation of instrument or a period immediately after completion of running of a program, any portion of body shall not be contacted with metallic portion (module or hot-lid) nearby the said mark; otherwise skin would be burnt.

4. Maintenance of instrument

In order to ensure full contact and good heat conduction between the test tube and the conical holes, the conical hole on the module shall be regularly cleaned with clean soft cloth soaked with a little absolute alcohol. The stained surface of this instrument, if any, shall be cleaned with soft cloth soaked with cleaning paste.

Warning!

During cleaning the instrument, its power supply shall be cut off. The instrument surface shall not be cleaned with corrosive cleaning agent.

5. After-sales service (The warranty content and scope are shown in the warranty sheet).

Warning!

After unpacking, immediately check the goods against the packing list. In case of damaged or missed goods, please immediately contact the supplier.
After qualification of acceptance, properly fill the product acceptance sheet and send (or fax) the copied sheet to the supplier for filing and maintenance.
After unpacking, the packing box and packing materials shall be well kept for future repairment. For the damage of instrument occurring during transporting to the repair department due to improper package, Hangzhou Bioer Technology Co., Ltd. shall bear no liability.

CONTENTS

CHAPTER I INTRODUCTION	1
1.1 Introduction of PCR technology	1
1.2 Example of PCR technology application scope	1
1.3 Features of GeneTouch Plus Thermal Cycler	2
1.4 Use of GeneTouch Plus Thermal Cycler	2
CHAPTER II FEATURES	3
2.1 Normal working conditions	3
2.2 Transportation and storage conditions	3
2.3 Basic parameters	3
2.4 Software functions	4
CHAPTER III PREPARATION	5
3.1 Structure diagram	5
3.2 Examination before startup	6
3.3 Startup	6
3.4 Installation of module unit	6
3.4.1 Installation procedures	6
3.4.2 Dismantling procedures	6
CHAPTER IV OPERATION GUIDELINE	7
4.1 Creating PCR program	7
4.1.1 Add or delete program segment	8
4.1.2 Segment temperature and constant temperature time	8
4.1.3 Cycle function	9
4.1.4 Extended parameters	10
4.1.5 Save/ Run	11
4.2 Running PCR program	12
4.2.1 Run new PCR program	12
4.2.2 Run saved PCR program	14
4.3 Set system parameters	15

4.3.1 Date & Time	15
4.3.2 Language	15
4.3.3 Backlight adjustment	16
4.3.4 Hot lid setting	16
4.3.5 Tone	16
4.3.6 Screen calibration	16
4.3.7 USB	17
4.3.8 Tm calculator	17
4.4 Distribution characteristics of gradient module	17
CHAPTER V CONNECT TO COMPUTER	18
5.1 System configuration	18
5.2 Install software	18
5.2.1 Install PC software	18
5.2.2 Install tool software	19
5.3 Online setting	20
5.3.1 Connect to PC	20
5.4 Run software	23
5.4.1 User management	23
5.4.2 File management	24
5.4.3 Equipment management	26
5.4.4 Other management	28
5.4.5 Run	29
CHAPTER VI FIRMWARE UPGRADING	30
6.1 Connect to PC	30
6.2 Network Enable Administrator setting	30
6.3 Software upgrading	32
CHAPTER VII FAILURE ANALYSIS AND TROUBLESHOOTING	33
7.1 Failure Analysis and Troubleshooting	33
Appendix 1: Wiring Diagram	35

CHAPTER I INTRODUCTION

The contents in this chapter include introduction of PCR technology, examples of PCR application, introduction of Thermal Cycler and features of GeneTouch(Plus) Thermal Cycler.

1.1 Introduction of PCR technology

Polymerase chain reaction (PCR) is a nucleic acid amplification that simulates natural DNA replication in vitro. It takes 2 DNA chains to be amplified as template, uses a pair of artificially synthesized oligonucleotide primer as mediator, and amplifies certain DNA fragment quickly and specifically by thermostable DNA polymerase. Ever since PCR technology was invented by Mullis in 1985 and thermostable DNA polymerase was discovered by Erlich in 1988, this simple, fast, specific and sensitive technology has been widely applied to life science areas at astonishing speed. Remarkable achievements have been witnessed in cytology, virology, oncology, genetic disease, forensic medicine, animal/plant immunology and etc. It is a milestone in contemporary molecular biology development.

1.2. Example of PCR technology application scope

Research:	Gene clone, dna sequencing, mutation analysis, gene recombination and fusion, protein-regulating dna sequence identification, transposition insertion site mapping, genetic modification detection, synthetic gene construction, clone construction, carrier expression, certain gene's incision enzyme diversity detection and etc.
Clinical diagnosis:	Bacteria (spirochete, mycoplasma, chlamydia, mycobacterium, rickettsia, diphtheria bacillus, pathogenic e. Coli, dysentery bacillus, aeromonas hydrophilic and c. Difficile and etc.); Virus (htlv, hiv, hbv, hcv, hpvs, ev, cmv, ebv, hsv, measles virus, rotavirus, parvovirus b19 and etc.); Parasite (malaria and etc.); Human genetic disease (lesh-nyhan syndrome, mediterranean anemia, hemophilia, bmd, dmd, cystic fibrosis and etc.)
Immunology:	HLA typing, T cell receptor or antibody diversity qualification, autoimmune disease gene mapping, lymphokine quantification and etc.
Human genome project:	DNA mark generated from scatter repetitive sequence, genetic map construction (detect DNA, polymorphism, sperm drawing), physical map construction, sequencing, expression map and etc.
Forensic medicine:	Crime scene specimen analysis, hla-dq α analysis and etc.
Oncology:	Pancreas cancer, rectal cancer, lung cancer, thyroid cancer, melanin cancer, hematological malignant tumor and etc.
Histology/population biology:	Genetic cluster research, evolution research, animal protection research, ecology, environmental science, experimental genetics and etc.
Paleontology:	Archeology and museum specimen analysis and etc.
Botany/zoology:	Animal inflectional disease diagnosis, plant pathogen detection and etc.

1.3. Features of GeneTouch Plus Thermal Cyclers

GeneTouch Plus Thermal Cyclers are PCR instruments with multiple functions and several applications. Below are their features:

- ◎ Use advanced thermoelectric refrigeration technology from ITI of US and thermoelectric refrigeration elements made under quality management of Japan, which are steady and reliable in quality.
- ◎ Temperature can be changed as fast as 4°C /second. The speed to increase or decrease temperature can be set as per need of experiment.
- ◎ Several modes for temperature control, better compatibility of reagent.
- ◎ Large LCD screen, user-friendly operation interface, simple and easy operation
- ◎ Power-off protection available, programs can continue after power recovery.
- ◎ Height and pressure of hot-lid can be set for different reaction tubes, which effectively prevent the reagent from evaporation and pollution.
- ◎ Connect to ordinary computer by RJ45 standard interface, which is easy for software upgrading.

1.4. Use of GeneTouch Plus Thermal Cyclers

Integrating a number of advanced technologies, GeneTouch Plus Thermal Cyclers meet the demand of different PCR experiments and rank top in similar products.

GeneTouch Plus Thermal Cyclers are attached with:

- 1) 0.2 ml standard centrifugal tube
- 2) Strip of 8 tube
- 3) Strip of 12 tube
- 4) Full/half apron plates

CHAPTER II FEATURES

This chapter introduces the usage, transportation, storage conditions of the instrument, as well as its basic parameters, performance and functions.

2.1 Normal working conditions

Ambient temperature: 10°C ~ 30°C

Relative humidity: ≤70%

Power supply: 100-240V ~ 50/60HZ

Caution: Before using the instrument, please make sure the working condition meets the above requirements. Especially the power line must be reliably earthed.

2.2 Transportation and storage conditions

Ambient temperature: -20°C ~ +55°C

Relative humidity: ≤80%

2.3 Basic parameters

Product name	GeneTouch Plus	
Product No.	BYQ6615	
Model	TC-EA-96GA	TC-EA-48DA
Module model	B-96GA	B-48DA
Sample size	96 holes ×0.2ml 96 holes full apron plates, 12×8 test tube bar half apron plates, no apron general	48 holes ×0.2ml+48 holes ×0.2ml,
LCD display	Color touch screen (6.5, 260,000 colors)	Color touch screen (6.5, 260,000 colors)
Temperature range	4°C ~99.9°C	4°C ~99.9°C
Max. heating rate Max. cooling rate	≥4°C /s	≥ 4°C /s
Temperature uniformity	≤ ±0.4°C (95°C) ≤ ±0.3°C (72°C) ≤ ±0.3°C (55°C)	≤ ±0.4°C (95°C) ≤ ±0.3°C (72°C) ≤ ±0.3°C (55°C)
Temperature control precision	≤ ±0.15 °C	≤ ±0.15 °C
Temperature fluctuation	≤ ±0.1°C	≤ ±0.1°C
Gradient temperature range	30°C ~99.9°C	30°C ~99.9°C
Gradient temperature range	1°C ~36°C	1°C ~30°C
Temperature range of hot lid	30°C ~110°C	30°C ~110°C
File saving amount	≥ 250	≥ 250
Energy consumption	600W	600W
Operation mode	Continuous running mode	Continuous running mode
Dimensions	345×250×270mm	345×250×270mm
Fuse	250V 8A Φ5×20	250V 8A Φ5×20
PC interface	RJ45	RJ45
Net weight	10kg	10kg

2.4 Software functions

- a) Edit the file (including file number, temperature and time of each segment, cycle times setting, file view, revision and deletion, automatic file connection, gradient temperature setting, the maximum paragraph, step and cycle times for editable file are 10, 100 and 99 respectively. The scope for gradient temperature setting is 1°C ~ 30°C.)
- b) Save the file
- c) Revise the file (adjust the rate for temperature rise/fall, refine temperature and time for cycling automatically , and display and calibrate the time.)
- d) Display the temperature, time, cycle times setting and real-time value during the file running (including sound prompt, total/rest time estimation for file running, failure protection and alarming.)
- e) Stop the file running (including pause the file running, stop the file running, recover automatically after power off.)

Caution: The above-mentioned software function is merely for reference. The software function would be modified without notice.

CHAPTER III PREPARATION

This chapter mainly introduces structure of the instrument and preparation before startup. When using the instrument for the first time, read the contents in this chapter carefully before startup.

3.1 Structure diagram



Caution: The fixed location can be adjusted according to your need. When fixing, the location must be determined. Then strip the pen buckle off from the back 3M rubber release layer, and fix it on the instrument.

Installation method: Take the touch pen out of the accessory, and strip the 3M rubber release layer at the back of the pen buckle after determining the fix location. Then paste it on the fixed location as shown.

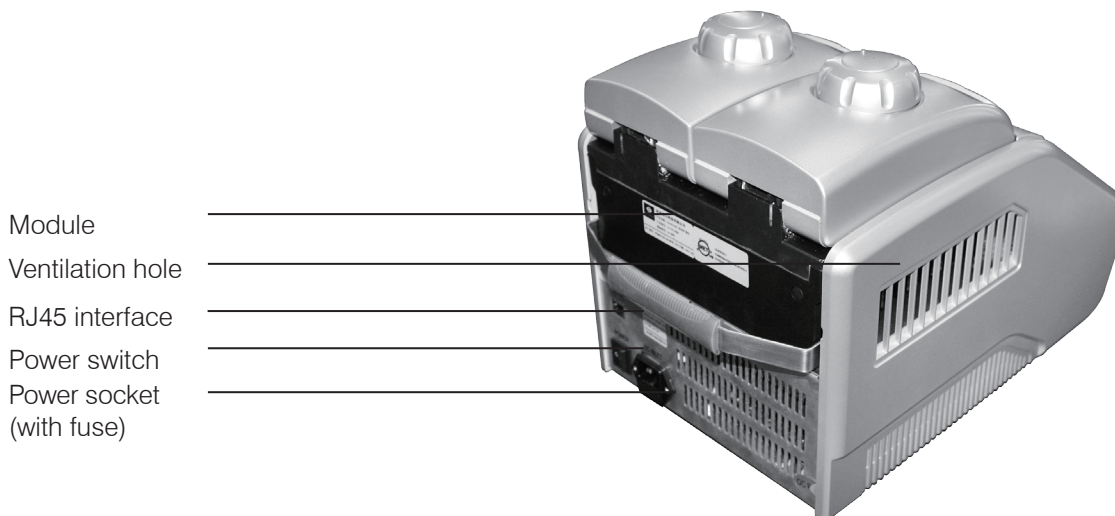

Caution: The fuse specification must be 250V, 8A, $\Phi 5$ 20. Use qualified product to replace the fuse. Contact fuse supplier or manufacturer when necessary.

3.2 Examination before startup

Please confirm the following contents before plugging in for powering on:

- 1 Whether the power supply conforms to the required voltage; (see power supply requirements in Chapter II of the file)
- 2 Ensure the plug of power cord has been reliably plugged in the socket;
- 3 The power cord is reliably grounded.

3.3 Startup

Turn on the power switch (turn the switch at "-"). The Thermal Cycler will produce one toot sound. It indicates that it is powered on.

At that time the screen is still black. Please wait for about 10~20 seconds. The main menu will then appear. Now you can edit, browse, alter and delete PCR Thermal Cycler file as well as other operations.

3.4 Installation of module unit

The host of the instrument is able to work only when it is connected with module unit. The installation and dismantling of the module unit can be completed by following the above-listed procedures.

3.4.1 Installation procedures:

- a) Put the module on the slot of the host, and lift the locking handle. Slowly push the module to make sure the locking handle is in place;
- b) Press the locking handle, and the module will automatically slide forward. The module is installed in place when the sound of "click" is heard.
- c) It can be normally started up and run.



3.4.2 Dismantling procedures:

- a) Cut off the power supply, and confirm that the module needs to be removed or be replaced;
- b) Lift the locking handle. The module will simultaneously slide backward after hearing the sound of "click";
- c) After sliding, the handle can be locked. The module can be directly removed; and the module unit is dismantled.



- Cautions:**
1. before installing or dismantling the module, make sure the power supply is cut off.
 2. When installing the module, slowly push the module to connect it with the host. Avoid damage to host plug caused by force.
 3. When dismantling the module, push the module along the slot slowly. Do not incline the module to prevent the connection line from snapping.
 4. The module unit of the instrument will automatically identified by the host for use after installation. No other operations are needed.

CHAPTER IV OPERATION GUIDELINE

This chapter provides detailed introductions of the methods for the edition, browsing, alteration and deletion of the PCR THERMAL CYCLER file, its running as well as setting of instrument system parameters, etc..

Caution: If sound occurs or the display is abnormal, or failure alarming and tone occurs during the process of the self-test of the instrument after the instrument startup, please cut off the power supply immediately and contact the supplier.

Caution: If the sample quantity in your experiment is less than the number of taper holes of the module, please try to distribute the sample test tubes evenly when placing tubes so as to ensure that the hot lid can be stably pressed on top of the test tube when running the file. Meanwhile, make the load of the module even to guarantee that the temperature changes of each test tube are uniform.

Caution: Turn the knob in a counterclockwise way as required in knob figure (press tightly in clockwise direction, and release in counterclockwise direction) before closing the lid until hearing twice clang sound. Then turn the knob in a clockwise way before startup. Turn another round after hearing twice clang sound. Twice clang sound will be heard no matter turning the knob in a counterclockwise or clockwise way. Unlock device knob can be released when pressing the unlock device and turning two rounds in a counterclockwise way simultaneously.

4.1 Creating PCR program

Click “new file”  in the main menu, enter setting interface of PCR program.

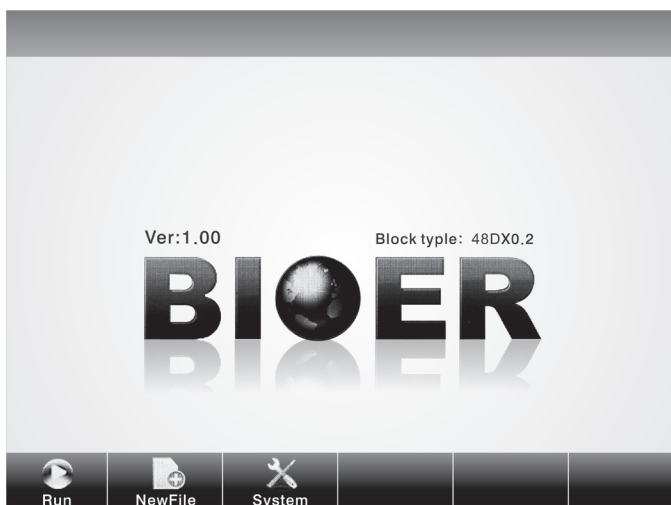

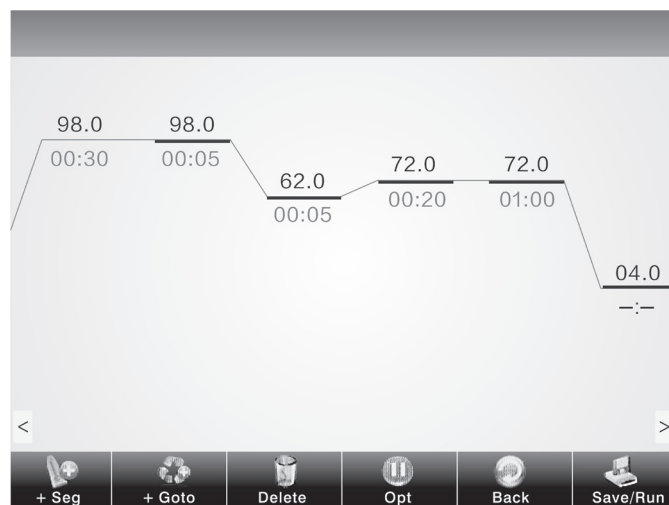

System main menu



Setting interface of PCR program

4.1.1 Add or delete program segment

You can add or delete program segments by clicking “+ segment”  or “delete”  at the bottom of the screen on the setting interface of PCR program.

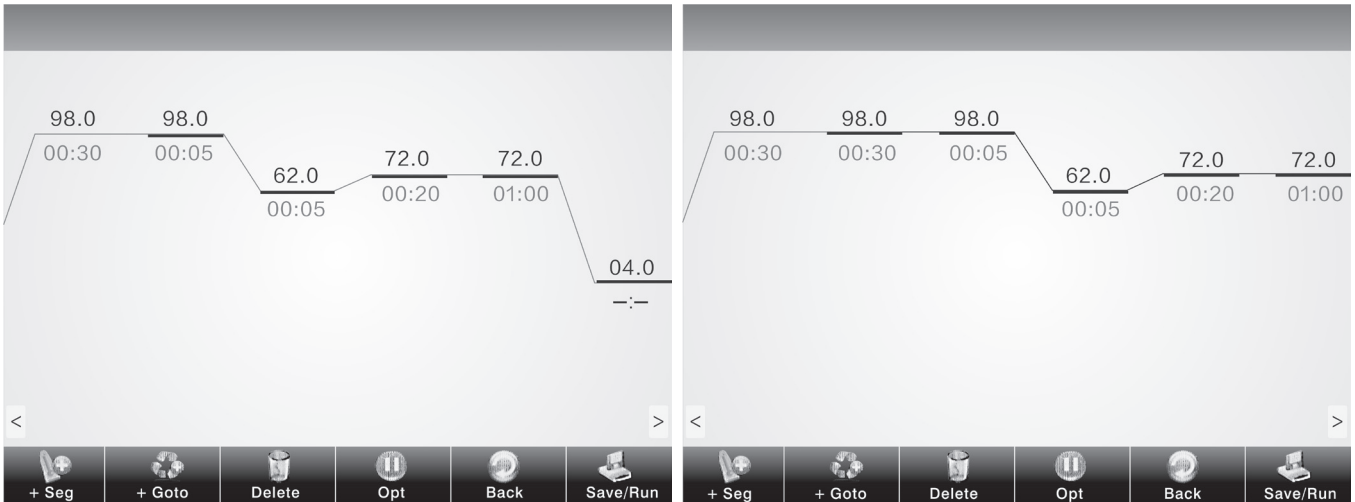

4.1.2 Segment temperature and constant temperature time

You can set temperature of program segment and constant temperature time by clicking temperature or time on the screen on the setting interface of PCR program.

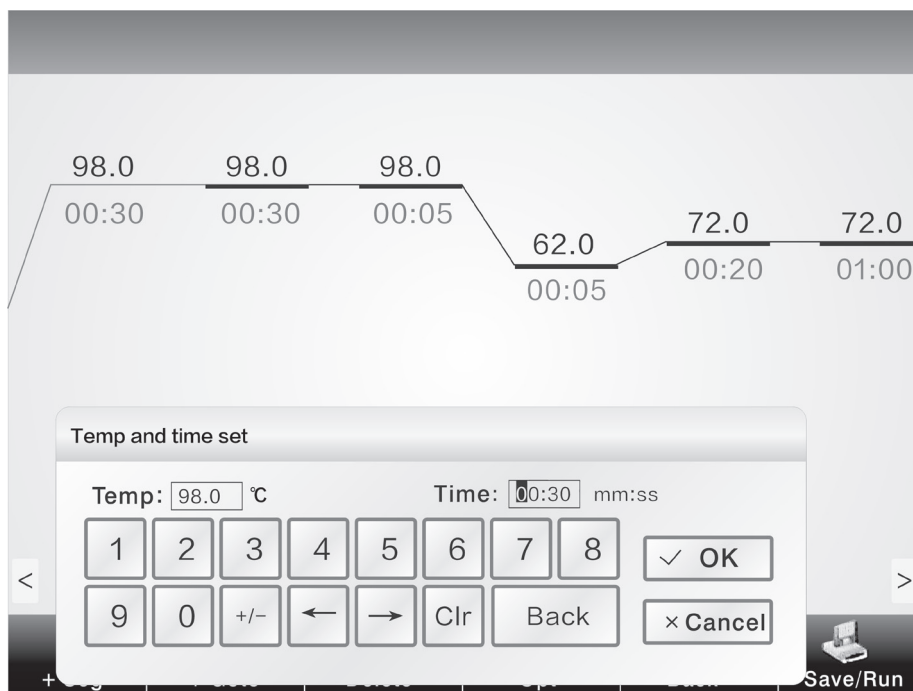

Edit program segment

4.1.3 Cycle function

On the setting interface of PCR program, first click the program segment that needs to add cycle function. Then click “+ jump”  to enter the setting interface of cycle function as shown in the right figure.

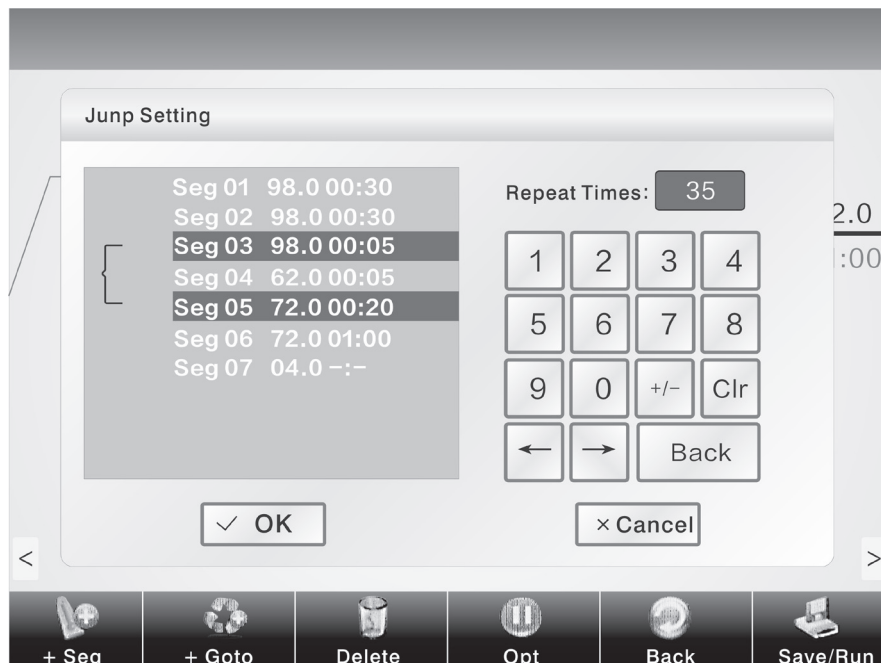

The jump function takes effect only when it jumps from the later program segment to the former one. See as the above figure seg05 → seg03. In setting, you need to enter the program setting status of seg05, then click “+ jump” to set cycle function.

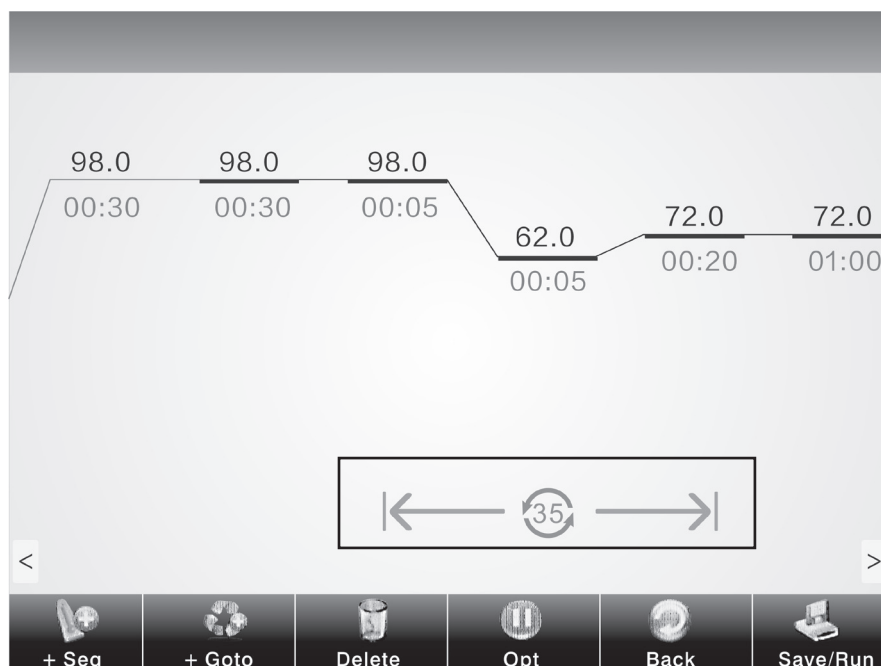

Finished jump setting

4.1.4 Extended parameters

You can enter extended temperature,  extended time, speed and gradient and other operations by clicking "extended parameters".

Extended temperature: temperature increment per cycle

Extended time: time increment per cycle

Speed: heating and cooling speed

Gradient: temperature gradient refers to the temperature difference among the most left column and the most right column of the module. The temperature of the most left column is set in the "temperature".

Display all: browse the current setting of extended parameters.

“ ← ” and “ → ” means to move the cursor left or right;
 “+/-” means to alter negative and positive data;
 “Clr” means to clear data.

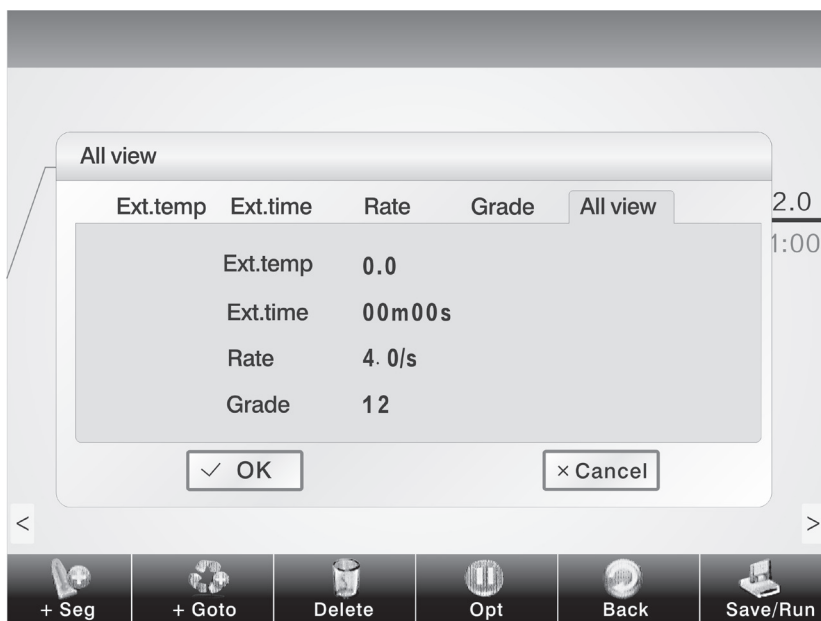

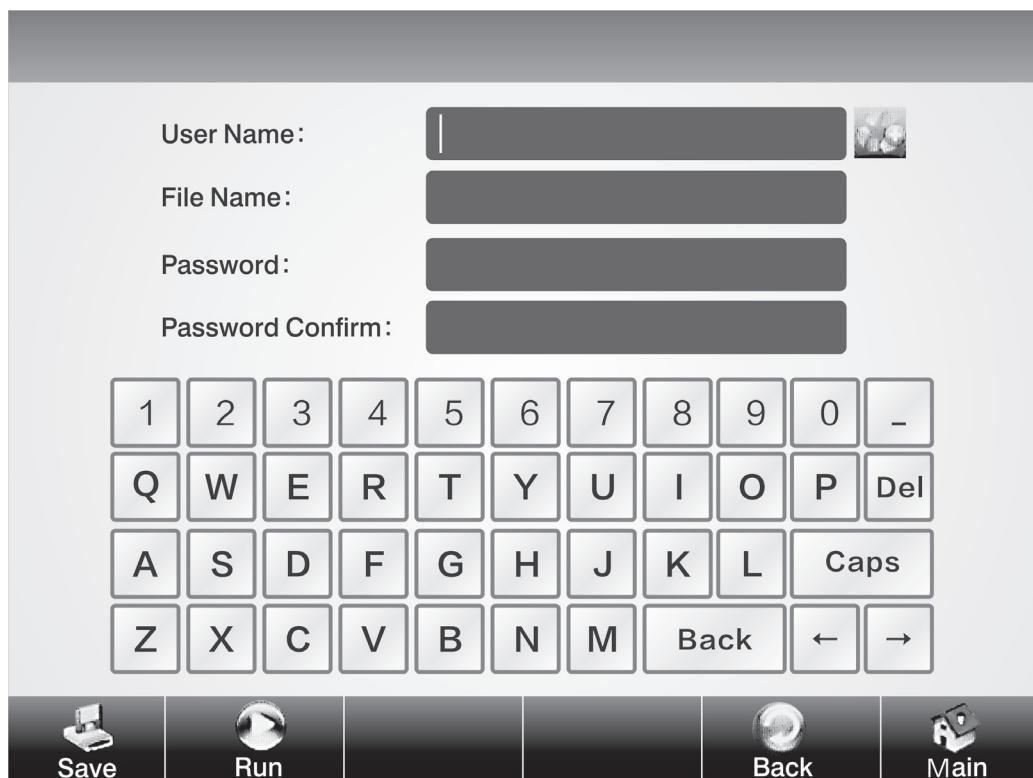

4.1.5 Save/ Run

After setting PCR program, click “save/ run”  to enter save interface as shown in the right figure. The user can input user name and file name in the interface, and also can adopt password assess mechanism for the data. Finally clicks “save”.



Save interface of PCR program

The user can directly select the existing file  under the user name by clicking icon  as shown in the right figure.

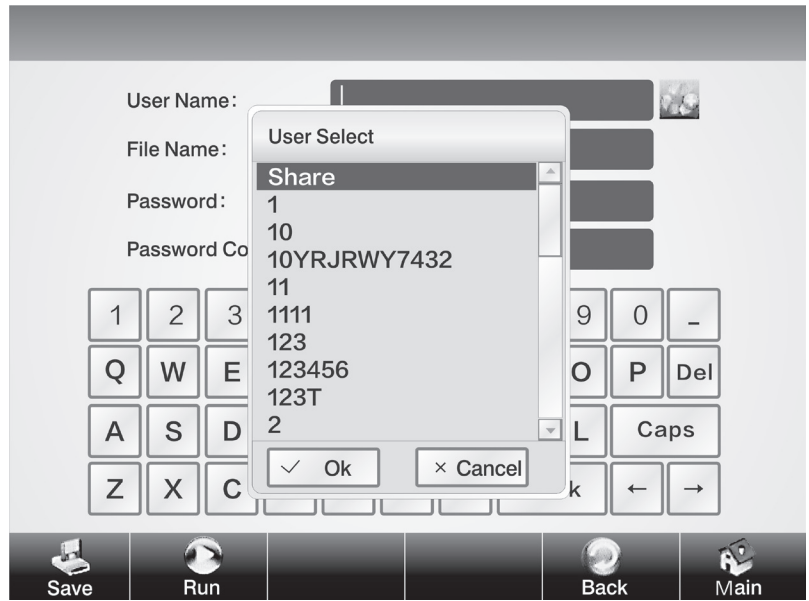

4.2 Running PCR program

4.2.1 Run new PCR program

1. After saving the new PCR program, click “run”  to enter parameter setting as shown below. The user can select module A or B, and alter temperature control mode, increased amount of fluid and temperature of hot lid (including opening/ closing hot lid function).

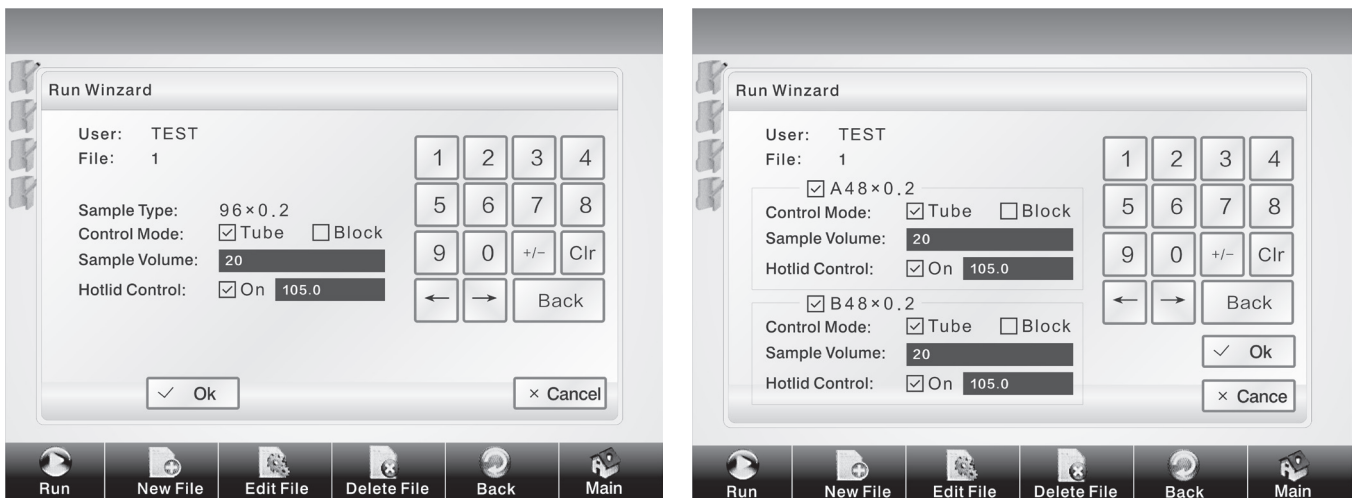

Parameter setting interface

The mode “Block” only takes into account of the temperature control in rise and fall of the module. Since the rise and fall of the reagent lags behind the module to certain extent, the actual temperature change process of the reagent is different from the program we set. The actual time during which the reagent reaches the setting temperature will be far less than the setting time (see the relationship between module temperature and reagent temperature in the right figure);

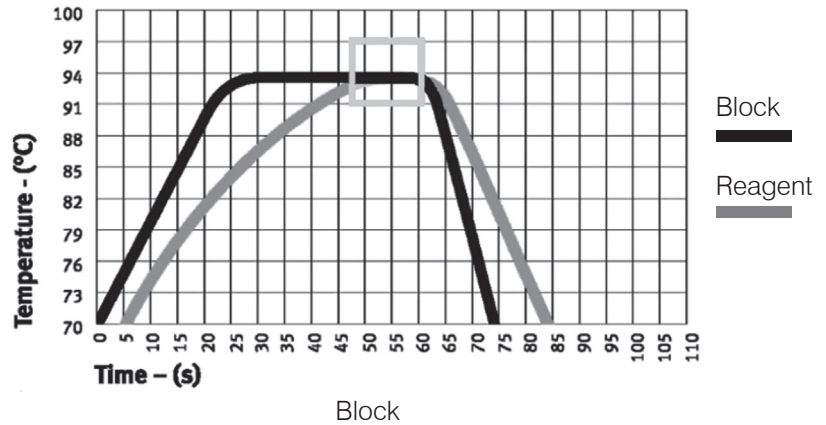

“Tube” mode takes into account of the backward process during which the rise and fall of the reagent lags behind the module. After reaching the setting temperature, there will be an overshooting process so that the reagent can reach the setting temperature at a quicker speed. In the setting time that similar to that of “Block” mode, the actual time during which the reagent achieves the setting temperature evidently prolongs (see the relationship between module temperature and reagent temperature in the right figure).

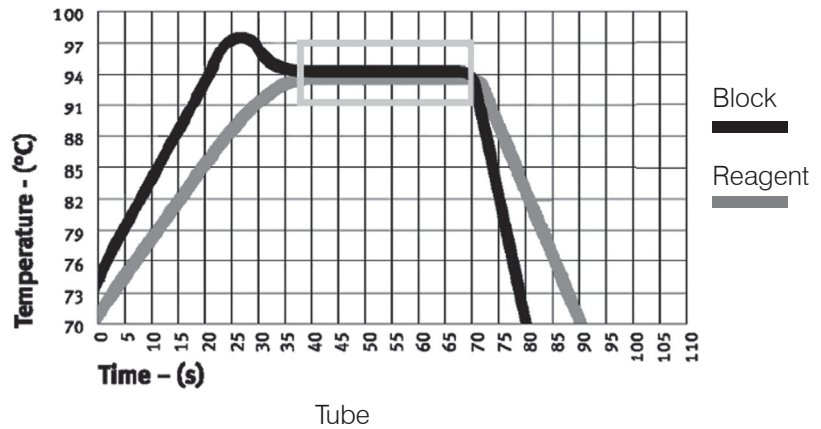

2. After setting temperature control mode, increased amount of fluid and temperature of hot lid, click “OK” to run PCR program;

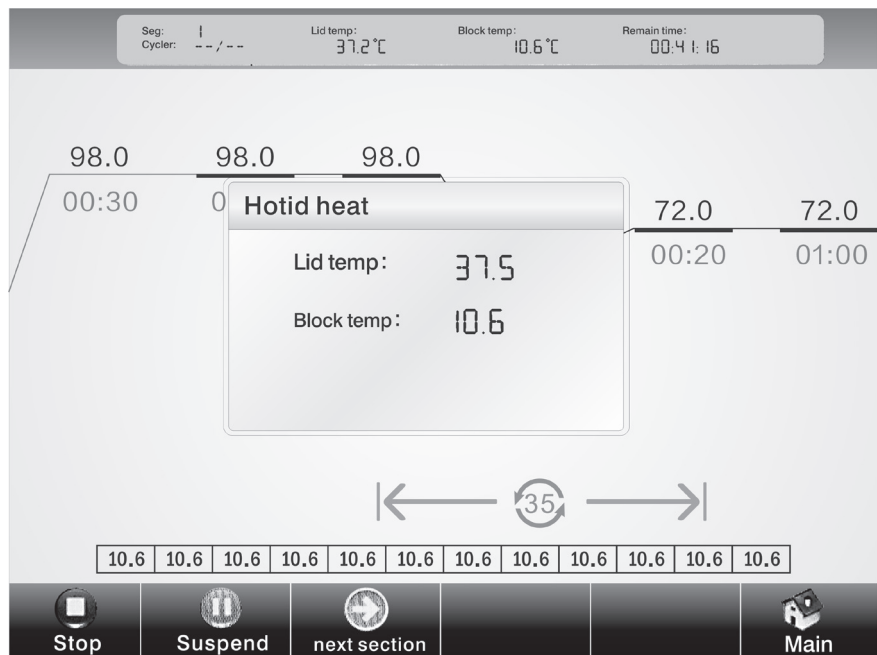

Program running interface

In the running process, the user can click “main menu” to return to the main menu or carry out other operations such as creating new file. If you want to return to the program running interface again, you can click the running interface at the top of the screen on the main menu.

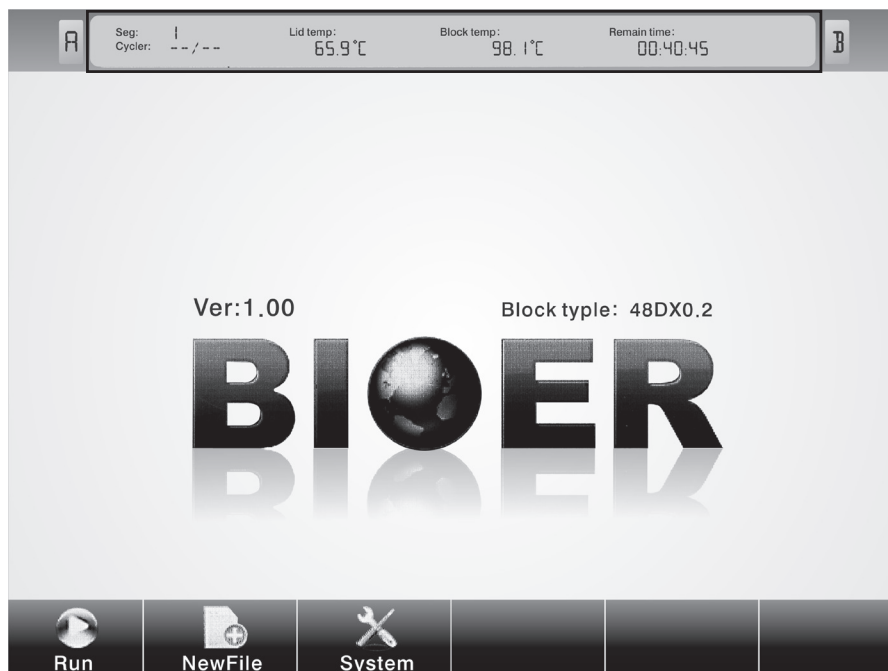

Main menu in program operation

4.2.2 Run saved PCR program

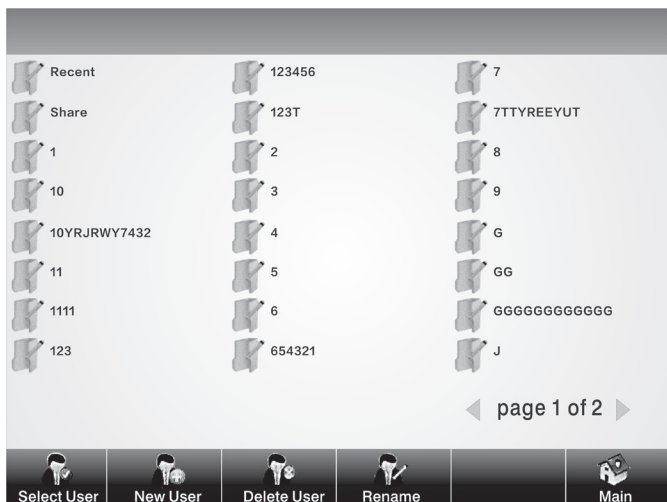

Option interface for users



Option interface for program file

Under the main menu, clicks “run” to enter option interface for users as the above figure. In the option interface for users, the user can create new user, delete user and rename, etc.;

Click corresponding user name to enter option interface for programs as the above figure. In the option interface for programs, the user can create new file, edit file, delete file and run selected file, etc..

4.3 Set system parameters

Click “system setting”  in the main menu to enter main menu of system parameter setting. Click touch screen to enter corresponding system setting interface.



Main menu of system setting

4.3.1 Date & Time

Click “date & time”  on the main menu of system setting to enter date & time setting interface. Click “OK” to save after setting.

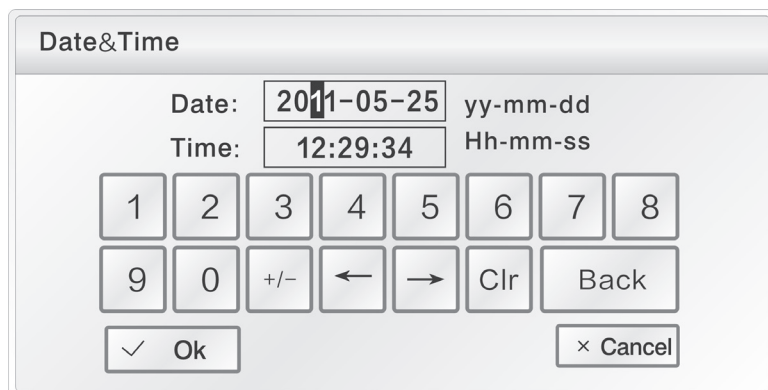

Date & time setting interface

4.3.2 Language

Click “language”  on the main menu of system setting to enter language setting interface. The instrument has integrated two languages namely Chinese and English. Click “OK” to save after setting.

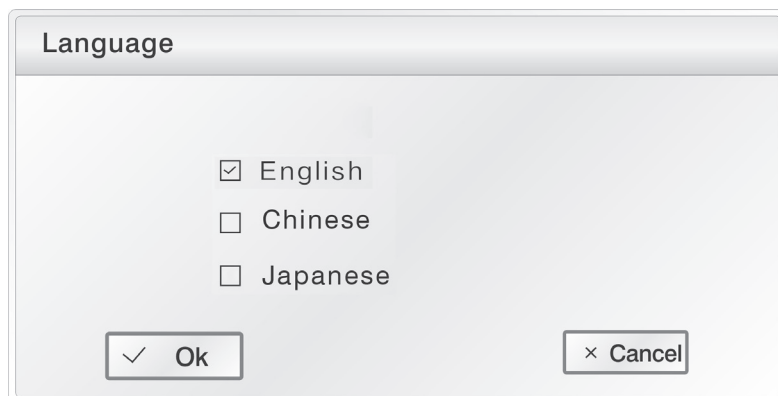

Language setting interface

4.3.3 Backlight adjustment

Click “backlight adjustment”  on the main menu of system setting to enter backlight adjustment setting interface. Press the navigation bar to move right and left to adjust backlight brightness of the instrument. Click “OK” to save after setting.

Backlight adjustment setting interface

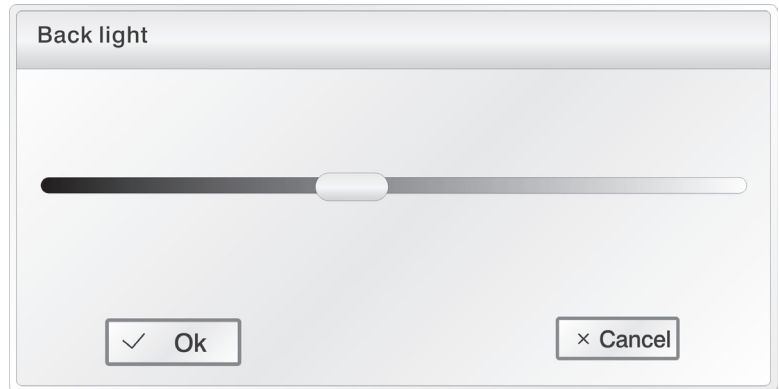

4.3.4 Hot lid setting

Click “hot lid setting”  on the main menu of system setting to enter hotlid setting interface. The first is when the module temperature below a certain value, need to shut down hotlid, prevent hotlid temperature on the influence of the temperature of module; The second is when cover heating, modules need to keep a constant temperature untill hotlid temperature up to hotlid set temperature. Click “OK” to save after setting.

hot lid setting interface

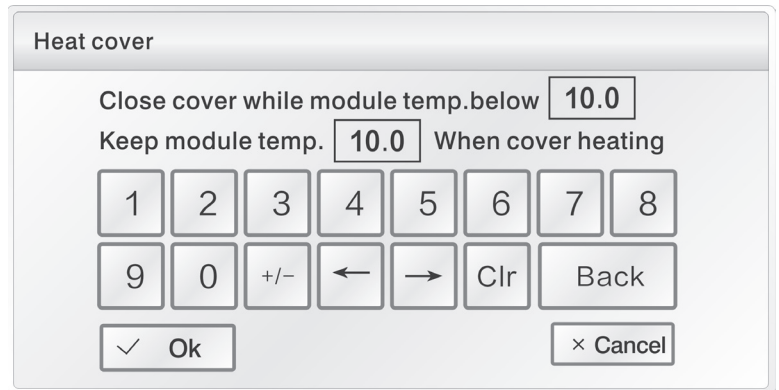

4.3.5 Tone

Click “tone”  on the main menu of system setting to enter tone setting interface. Click “OK” to save after setting.

Tone setting interface

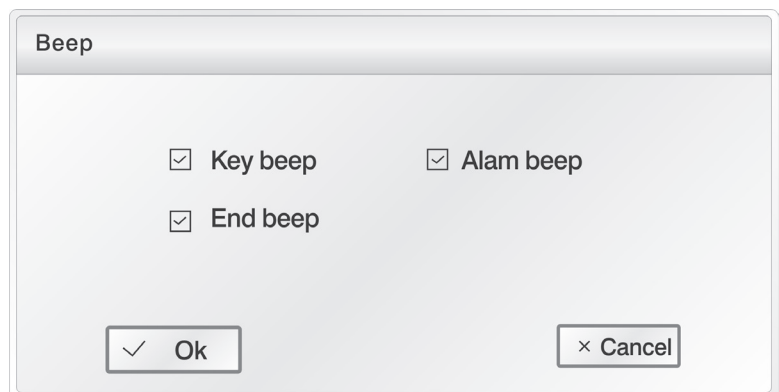

4.3.6 Screen calibration

Click “screen calibration”  on the main menu of system setting to enter screen calibration setting screen. In the setting process, you can finish screen calibration function by clicking upper left corner of the screen and figure center at the lower right center in turn with touch pen as per the prompt.

Screen calibration interface

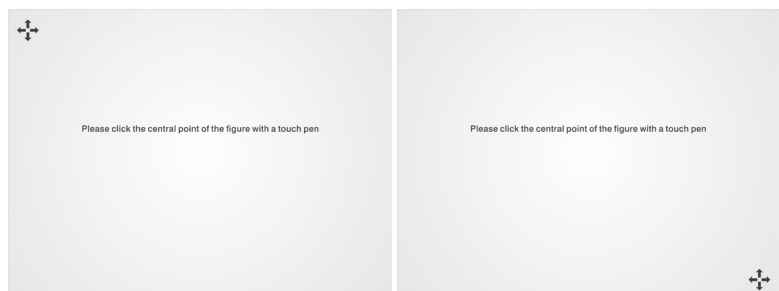

4.3.7 USB

Insert USB, and click “USB”  on the main menu of system setting. The equipment will automatically search for U disk. The user can export file to the U disk after successful searching.

USB search interface

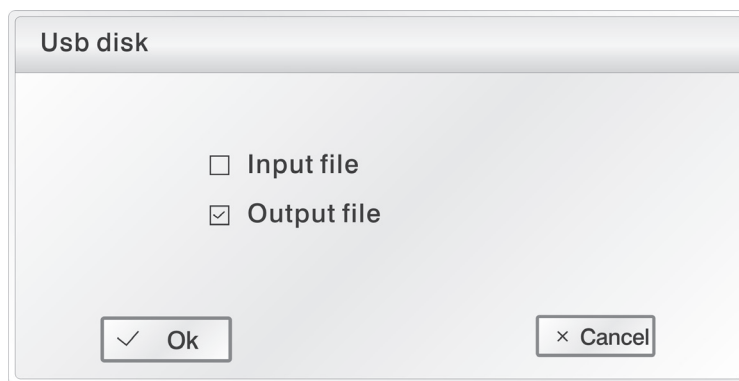

- Caution:**
1. USB read-write user number is 100, every user' s file number is 250.
 2. USB read-write fixup list, USB root list descended pcrex folder,use ' xx.ebr' file of the folder.
 3. Every user is one son folder of pcrex folder.
 4. Forbid to insert and pull out USB flash memory very fast. To protect apparatus and USB flash memory,if insert and pull out USB flash memory, the apparatus will close USB function until the next boot-strap.
 5. The operation method for double module is the same, the link of USB flash memory is only for two modules under the original interface.

4.3.8 Tm calculator

Click “Tm calculator”  on the main menu of system setting to enter tm calculator interface. There are two blank box in the interface through the keyboard input annealed product,click “Calculate” to calculate tm value.

Tm calculatoe interface

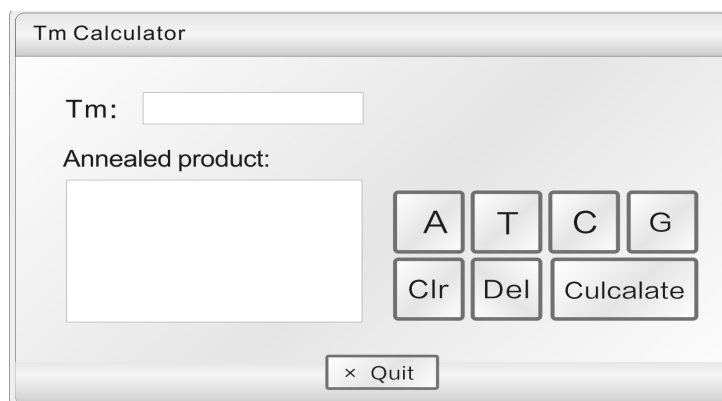

4.4 Distribution characteristics of gradient module

The gradient module adopts 2 temperature control units. The temperature gradient distributes like a curve. See as the following figure (set temperature at 40°C , and temperature gradient at 20°C). Each hole temperature gradient of the module do not distribute evenly. Temperature difference of each hole in the middle of the module will be larger than that of holes on the two sides of the module. Therefore, when operating gradient module, temperature of each hole shall be subject to the temperature displayed on the instrument.

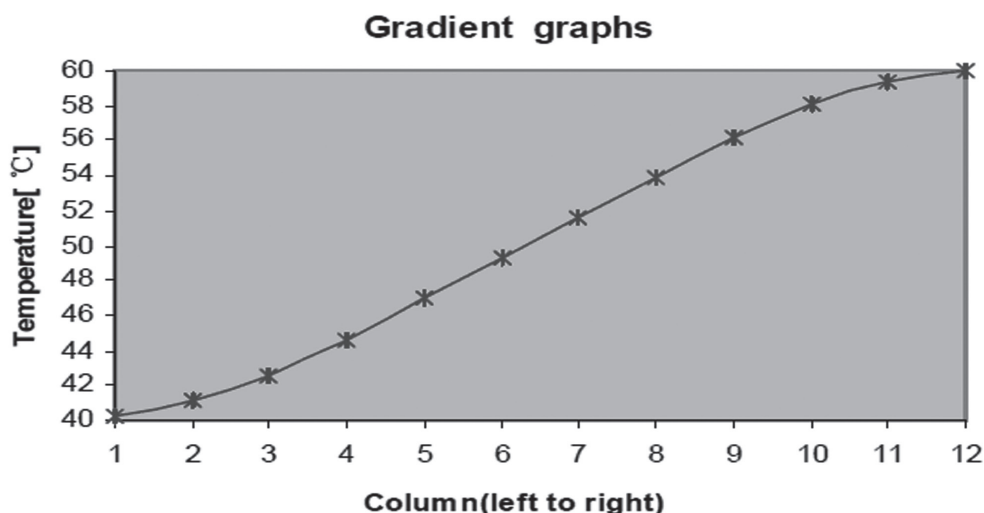

CHAPTER V CONNECT TO COMPUTER

5.1 System configuration

System environment:	Operating system:	Windows XP/Windows Vista/Windows 7
	Operating environment:	Net Framework2.0
	Other software:	PDF reader
Minimum configuration:	CPU:	Pentium(R) 4
	Memory:	1GB
	Hard disc:	10GB

5.2 Install software

5.2.1 Install PC software

Click "ThermalCyclerSetup.exe" in CD-ROM to install Gene Touch online program. 30pcs GeneTouch instruments can be controlled simultaneously by connecting to computer program.

1. Click and run "ThermalCycler Setup.exe" to select installation language, and click "OK";

2. Select installation location of the software, and click "next";

3. Click "next";

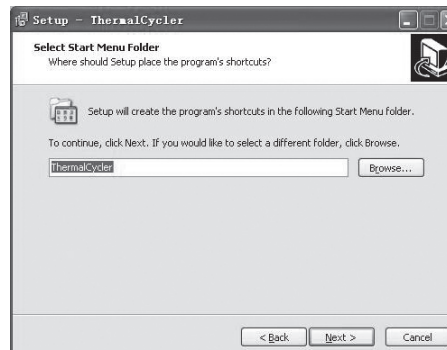
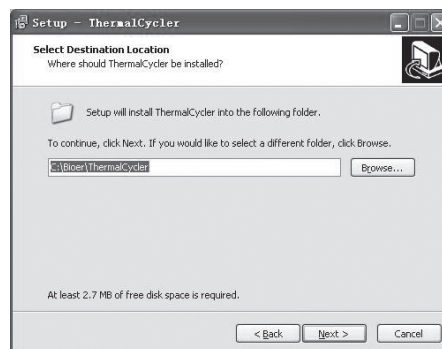
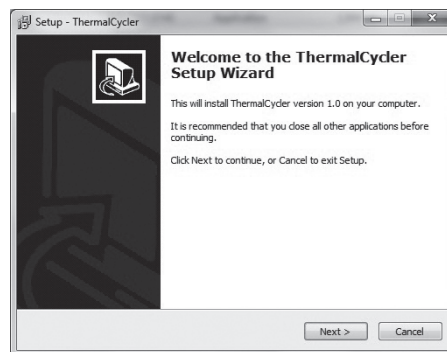

4. Click "install";

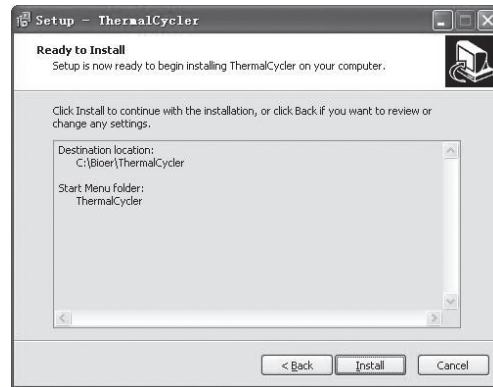

5. Finish installation. Click "finish".

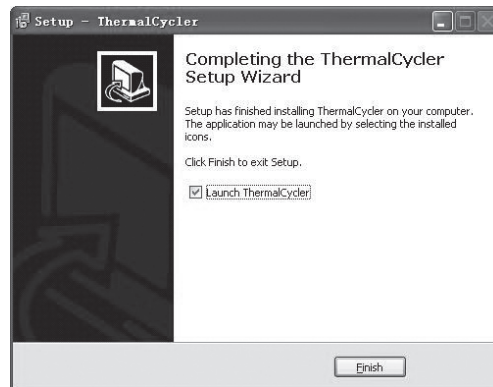

5.2.2 Install tool software

1. Click and run nead_setup.exe.

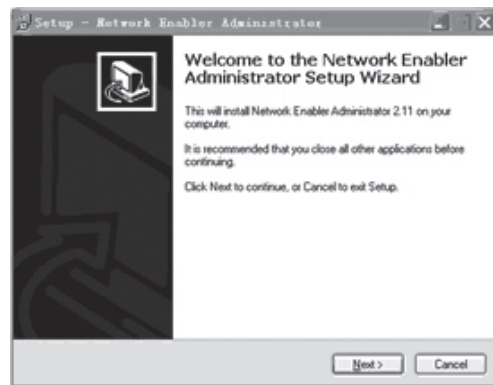

2. Click "Next".

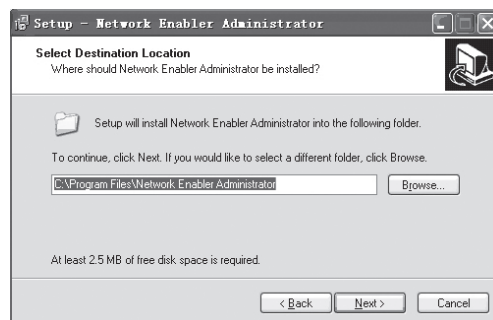

3. Select installation list, and click “Next”.

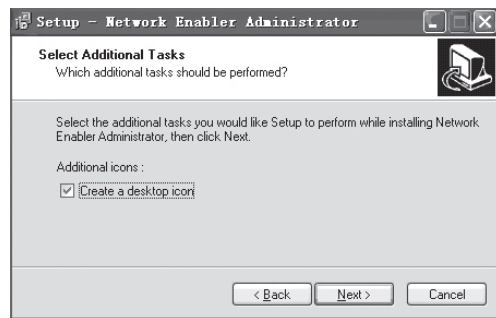

4. Click “Install”.

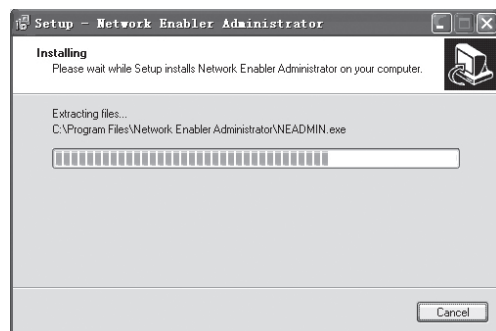

5. Finish installation. Click “Finish”.

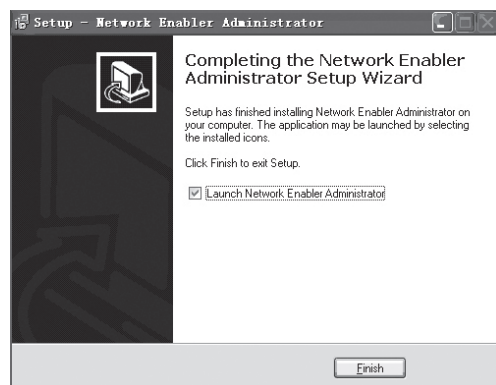

5.3 Online setting

5.3.1 Connect to PC

Connect the equipment with the computer through network cable (intersect, connection B).

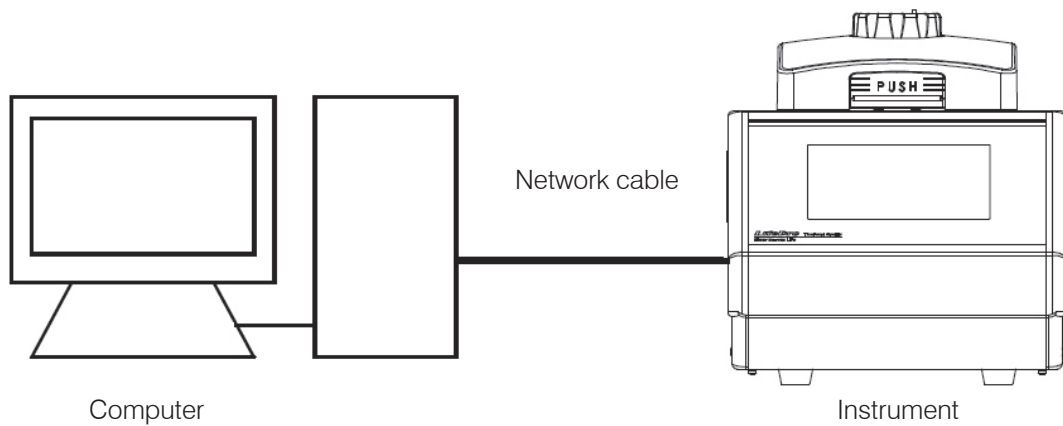

1. Run Network Enable Administrator tool software;

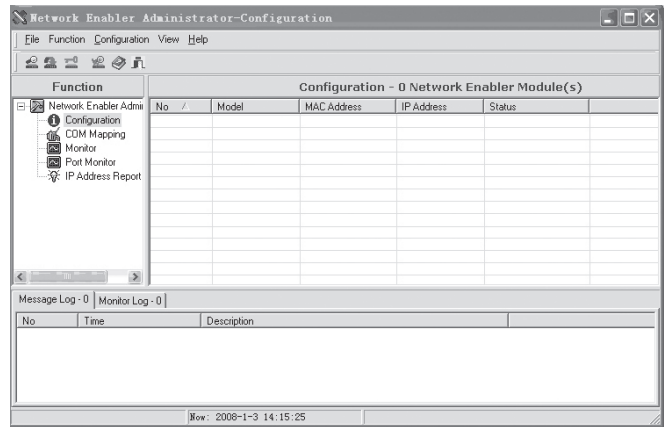

2. Click search button  or right click Broadcast Search option in Configuration, the tool will automatically search for the equipment.

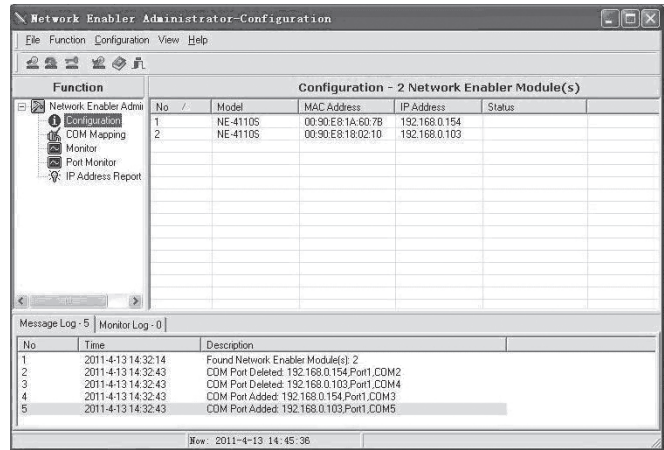

3. Double click the network number searched in list column to enter configuration setting page as follows.

(1) Click Network option, and select "Modify".
Input IP address and subnet mask.

The IP address of the instrument shall be in the same network segment with that of computer. For example, if the computer IP is 192.168.0.1, then the instrument IP shall be set as 192.168.0.XXX. Among them, the range of XXX is 2~254, and cannot be the same with computer IP.

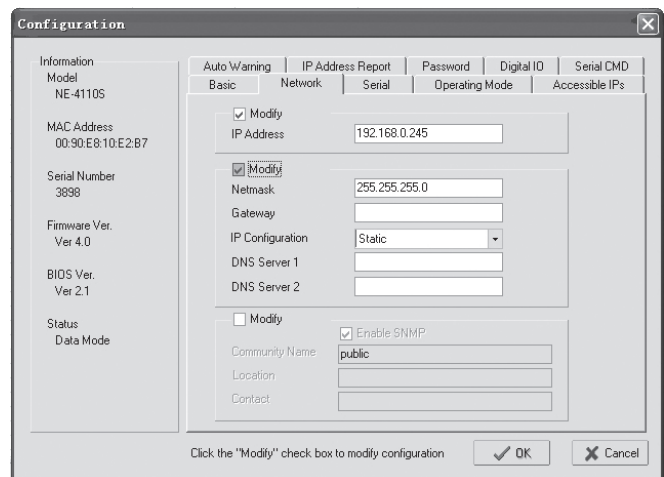

IP address setting

(2) Click Operating Mode, and select “Modify”. Click “Settings”, and operating mode will pop for selection. Select “TCP Server Mode”, and select “OK”.

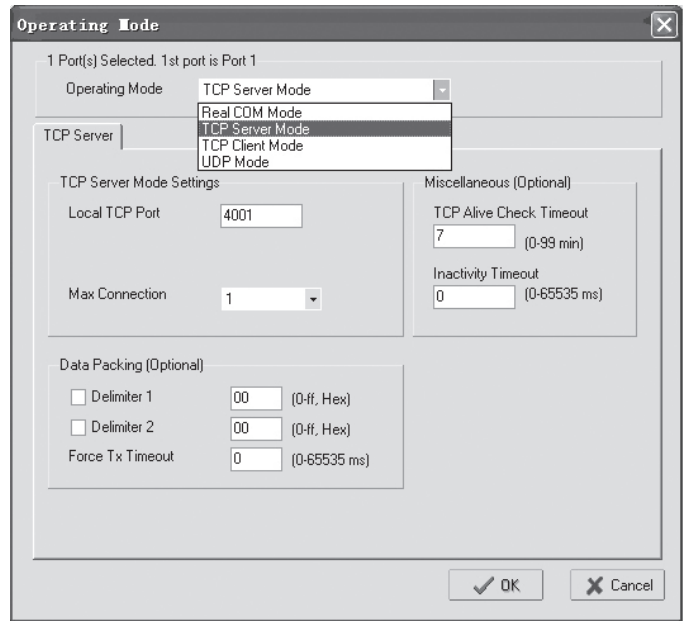

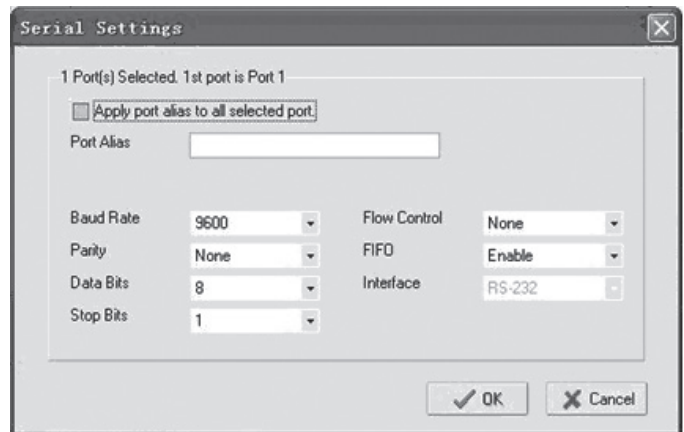

Operating Mode setting

(3) Click Serial option, and set in the Serial Settings window that pops. The specific parameters are as follows. Click “OK” after finishing setting.



Serial Setting

(4) Click “OK” to finish Configuration setting. 4. Click “COM Mapping” and “Add target”  to add target instrument. Carry out COM port settings in the pop-up dialog box. Click “OK” after finishing. Click “Apply Change”  to save altered setting.

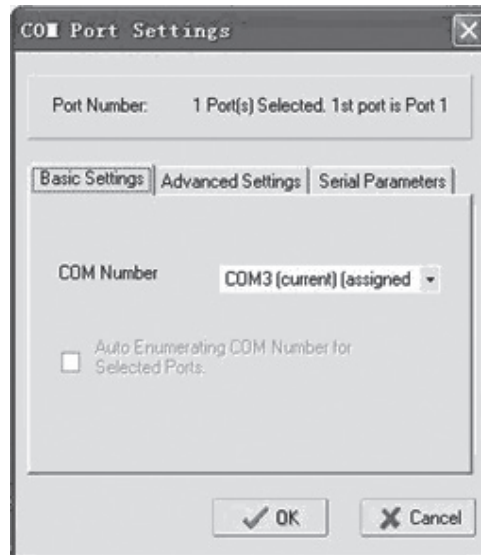

COM port settings

5.4 Run software

Comprise user management, file management and equipment management, etc..

1. Menu bar
2. Instrument contents
3. File display and edition area
4. Display area of running status
5. Status bar

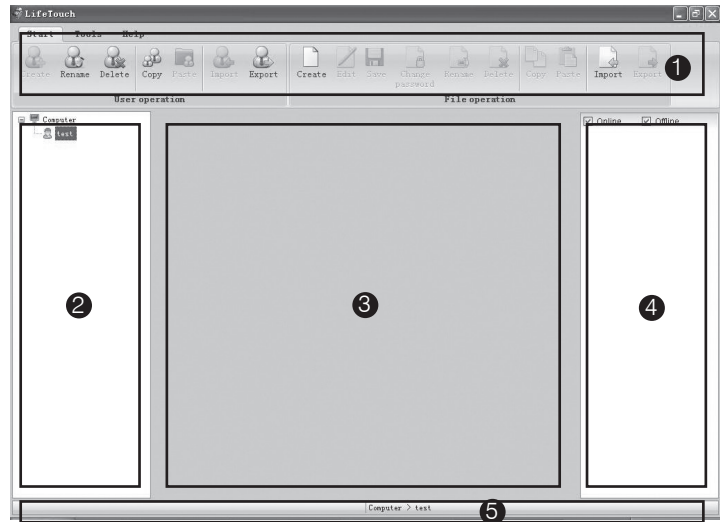

5.4.1 User management

Include creating, renaming, deleting, copying, pasting, importing and exporting user, etc..



1. Create user

Select equipment name sub-item in equipment list and click "create" , or right click "create user". The user name shall not be empty; The max length of user name is 12 bytes; The user name shall only contain numbers and letters (under half-width mode). A same user name cannot be used for more than one time in a same instrument.

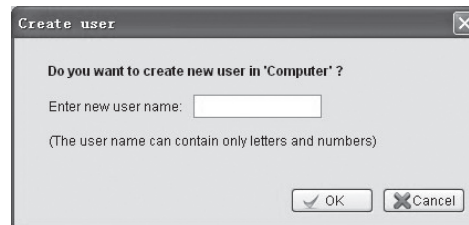

2. Rename

Select the user needing to be renamed in the equipment list, and click "rename" , or right click "alter user name". Click "OK" to save after inputting user name. It cannot be renamed when the file under the user name is opened;

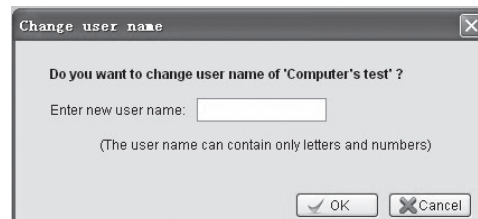

3. Delete user

Select the user needing to be deleted in the equipment list, and click "delete" , or right click "delete user" to delete. The program file under the user name will be simultaneously deleted when deleting the user.

4. Copy

Select the user needing to be copied in the equipment list, and click “copy” , right click “copy user” in the menu to copy the user and the program file under the user name. It cannot be copied when the program file under the user is being edited.

5. Paste

Select the user sub-item under equipment option in the equipment list or equipment option in the equipment list, and click “paste” , or right click “paste” in the menu to paste the user and the program file under the user name.

If the copied user has already existed, it will prompt whether to cover when pasting;

If the program file under the existing user name is in use, then pasting cannot be carried out;

Pasting may be finished by dragging mouse.

6. Import user

Click “import”  to select the folder saved by the user in the pop-up dialog box. Click “OK” to import user.

If the user selected has no program file, then user cannot be imported;

If there is same user name, then it will prompt whether to cover in importing;

If the program file under the same user name is in use, the user cannot be imported.

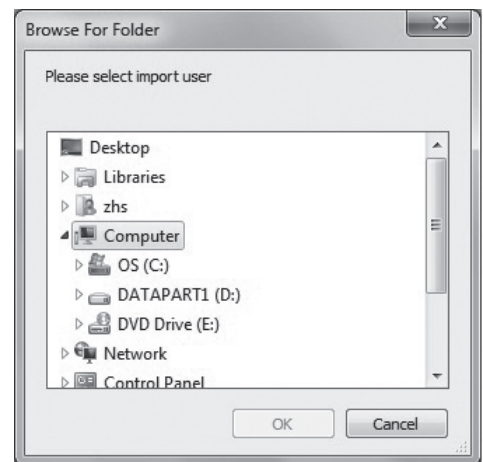

7. Export user

Click “export”  to select the folder saved by the user. Click “OK” to export user.

If there is same user name, then it will prompt whether to cover in export;

If the program file under the user is being edited, then the user cannot be exported.

5.4.2 File management

Include creating, renaming, deleting, copying, pasting, importing and exporting user, etc..

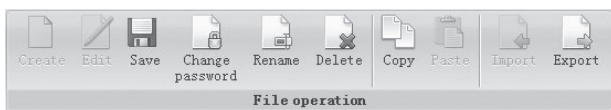

1. Create

Select the user that needs to create file, and click “create” . Input file name and password, and click “OK”.

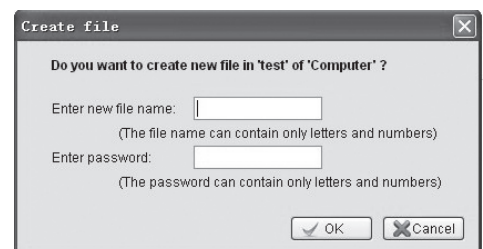

2 Edit and save

Select the file that needs to be edited, and click “edit”  , or right click “edit file”. Click “save”  in the menu bar after finishing edition.

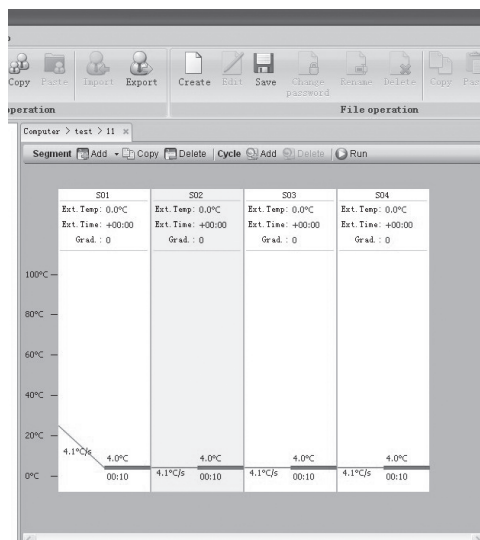

3. Alter password

Select the file that needs to alter password, and click “alter password”  . Input old and new passwords in the pop-up dialog box, and click “OK” to save.

If the selected file is not protected by password, then it only needs to input new password.



4. Rename

Select the file that needs to be renamed in the equipment list, and click “rename”  . It cannot be renamed when the file is opened;

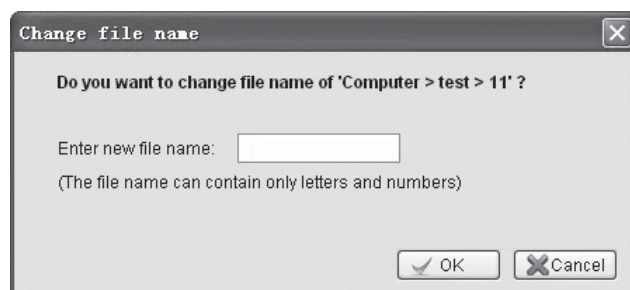

5. Delete file

Select the file that needs to be deleted in the equipment list, and click “delete”  .

If the file is being edited, then it cannot be deleted;

If the file is protected by password, then it cannot be deleted unless inputting correct password.

6. Copy

Select the file that needs to be copied, and click “copy”  , or right click “copy file” in the menu to copy the file. If the file is being edited, then it cannot be copied.

7. Paste

Select the equipment option in the equipment list, and click “paste”  , or right click “paste copied file” in the menu to paste the program file under the user and the user name.

if the copied user has already existed, then it will prompt whether to cover in pasting;

If the program file under the existed user name is being used, then it cannot be pasted.

You can use mouse to drag and paste.

8. Import file

Click “import”  , and select the folder of the user in the pop-up window. Click “OK” to import file.

If there is same file name, then it will prompt whether to cover in importing;

If the file with the same name is in use, then it cannot be imported.

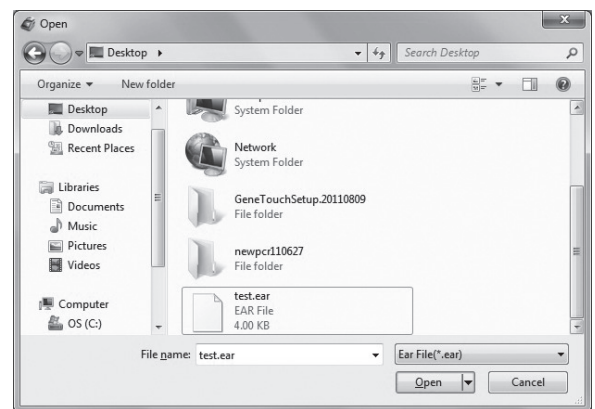

9. Export file

Click “export”  , and select the folder saved by the user in the pop-up window. Click “OK” to export file.

If there is same file name, then it will prompt whether to cover in exporting;

If the file is being edited, then it cannot be exported.

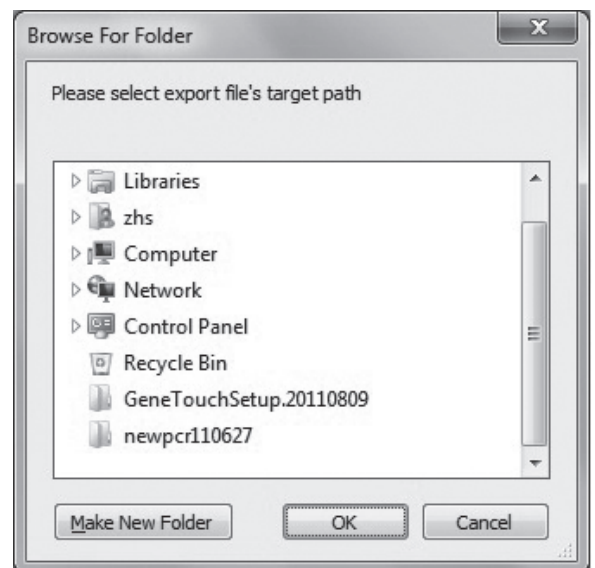



5.4.3 Equipment management

Include connection operation (connection and disconnection) and instrument management (searching for instrument, adding instrument, editing instrument, removing instrument and showing all instruments).



1. Connect

Select equipment name sub-item in the equipment list and click “connect”  , or right click “connect equipment” in the menu. It will show  in connection; show  in disconnection.

2. Disconnect

Select equipment name sub-item in the equipment list and click “disconnect”  .

If the file or system parameters in the equipment are being edited, then the dialog box will pop up, prompt for save;

3. Search for instrument

Click “search for instrument”, then a dialog box like the right figure will appear;

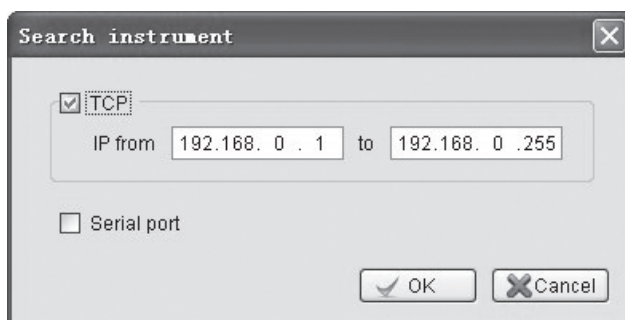

Select added equipment, and input equipment name.

Click “OK” to save.

If the instrument needs to be connected, please select “automatically connect”.

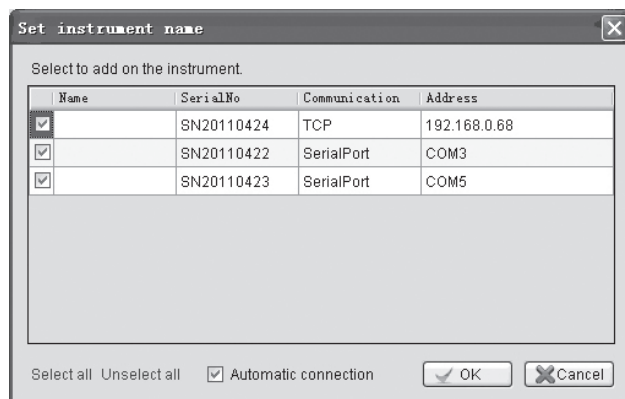

4. Add instrument

Click “add instrument”, and a dialog box like the right figure will appear. Input instrument name and address. Click “OK” to add instrument.

The instrument name shall not be empty, and the max bytes shall be 12;

Only numbers and letters are allowed in the instrument name;

The same instrument name is not allowed;

The instrument address shall not be empty, and the same address is not allowed to be used in different instruments.

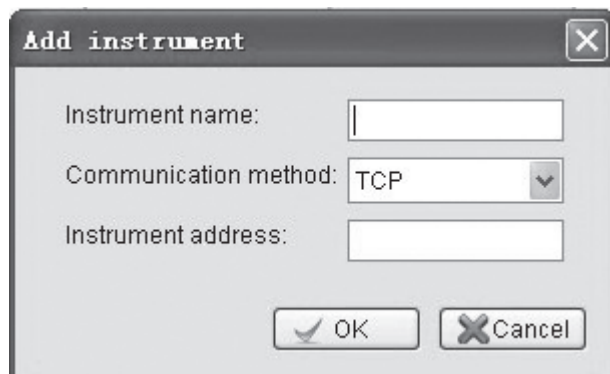

5. Edit instrument

Select equipment name sub-item in the equipment list and click “edit instrument”  . An equipment edition dialog box like the right figure will pop up; input instrument name and instrument address.

When connecting the instrument, the instrument address cannot be edited.

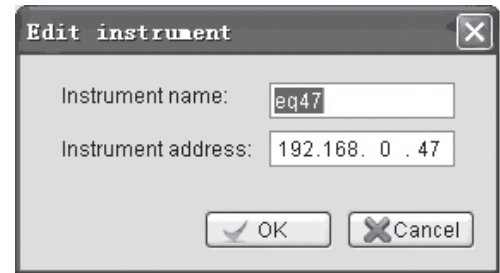

6. Remove instrument

Select equipment name sub-item in the equipment list and click “remove instrument”  .

The instrument cannot be removed when it is connected.

7. Show all instruments

Click “all instruments”  , and a list of all instruments will appear to show all instruments information.

8. Instrument system information

Select system setting, a setting dialog box like the right figure will appear. Instrument system information contains beep alarm, key sound, completion sound, temperature keep sound and hot lid setting (the lowest temperature of hot lid and module retention temperature). Clicks “save” after finishing setting.

The lowest hot lid temperature range: 0°C ~99.9°C .

Module retention temperature range: 0°C ~30°C .

The system information cannot be set when the instrument is disconnected;

When there is only single module in the connected instrument, the display area of module B cannot be altered.

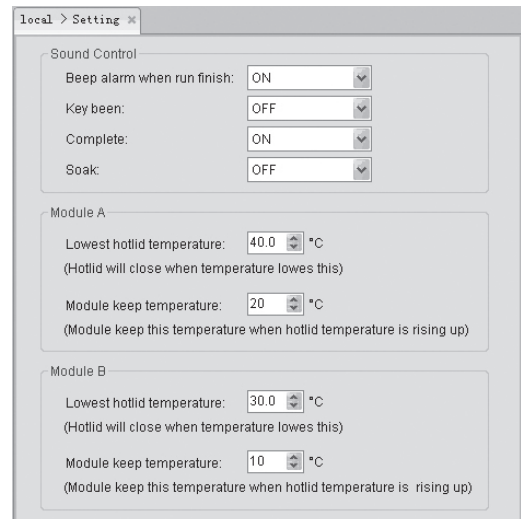

5.4.4 Other management

1. Temperature gradient

Click “temperature gradient”  in the menu bar, and a gradient dialog box as follows will pop up.

Temperature gradient range

Starting temperature: 30°C ~99°C

Gradient temperature: 0°C ~30°C

(When the gradient temperature is higher than 26 degrees Celsius , the starting temperature shall not be less than 45.)

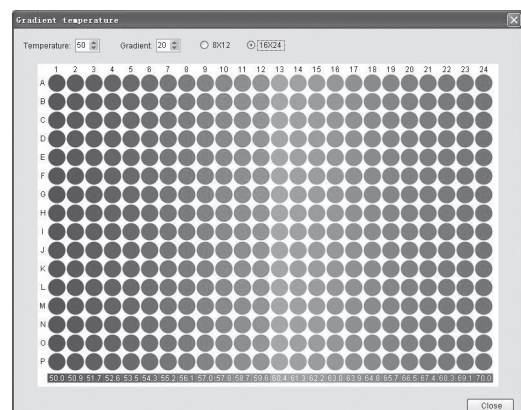

2. System help

Click “help” , then the help file will appear.

3. Software edition

Click “about” , the system dialog box will pop up, and the software edition can be referred to.

5.4.5 Run

1. Run file

Open the file, and click “run” , then a “run file” dialog box like the right figure will pop up. Select instrument, module, test tube type, amount of increased fluid, temperature control mode, hot lid temperature and running method (limited to Verit Module). Click “OK” to run program.

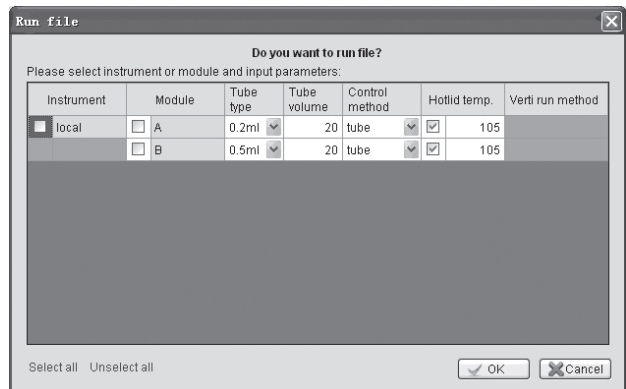

After running the file, the running status on the right of the main menu shows like the right figure.

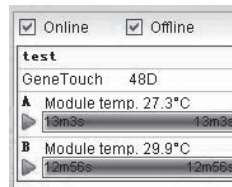

Details of instrument operating status are as follows.

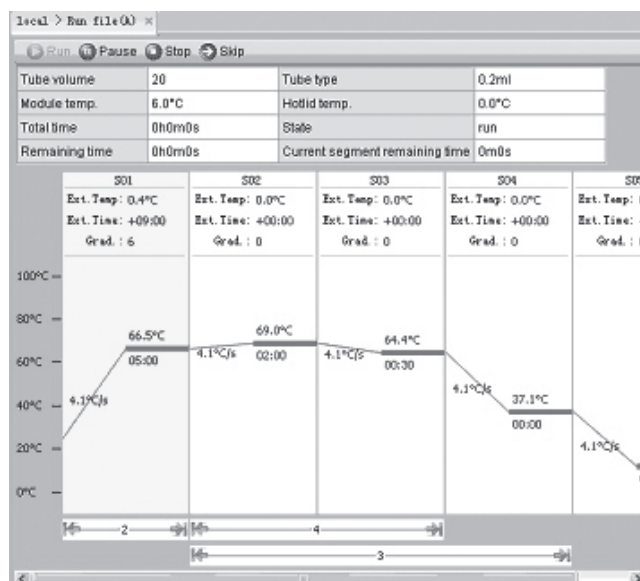

2. Browse running history

Right click system history, and a history table as follows will pop up.

	Module name	User name	File name	Begin time	End time	State
1	A	user002	file0021	2011/04/11 13:29:04	2011/04/11 13:31:20	UserSto
2	A	user	file001	2011/04/11 18:42:38		Run
3	B	user	file001	2011/04/11 18:42:38		Run

CHAPTER VI FIRMWARE UPGRADING

6.1 Connect to PC

Connect the equipment with computer by network cable. Turn on the equipment power to make the equipment on standby.

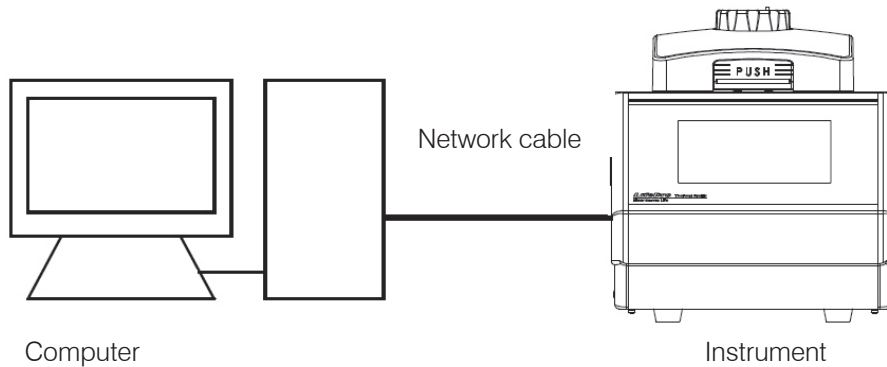

6.2 Network Enable Administrator setting

1. Run Network Enable Administrator tool software. When upgrading the instrument, communicate with virtual device mapping used.

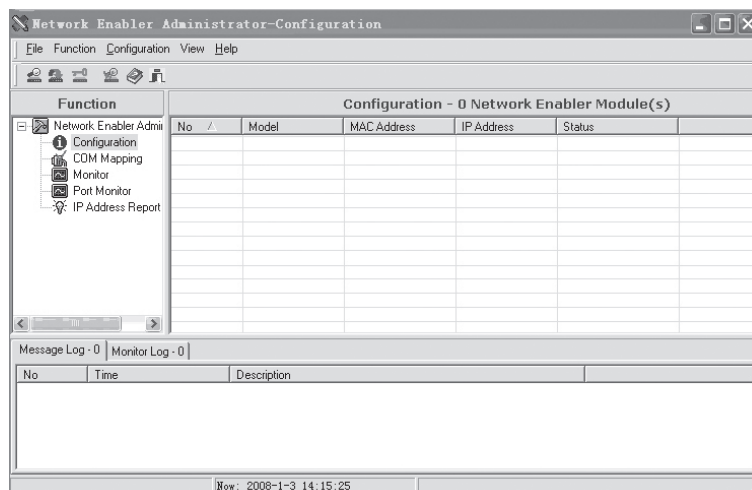

2. Click search button , or right click Broadcast Search option in Configuration, the tool will automatically search for the equipment.

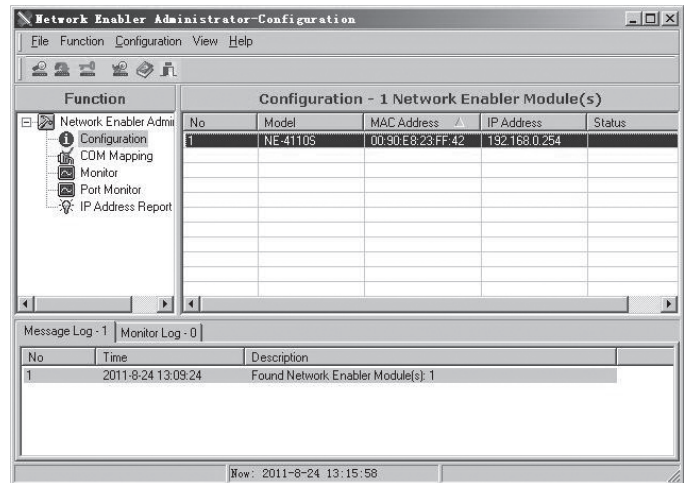

3. Double click the network number searched in list column to enter configuration setting page like the right figure.

(1) Click Network option, and select "Modify". Input IP address and subnet mask.

The instrument IP address shall be in the same network segment with computer IP address. For example, if the computer IP is 192.168.0.1, then the instrument IP address shall be set as 192.168.0.XXX. Among them, the range of XXX is 2~254, and cannot be the same with computer IP.

IP address setting

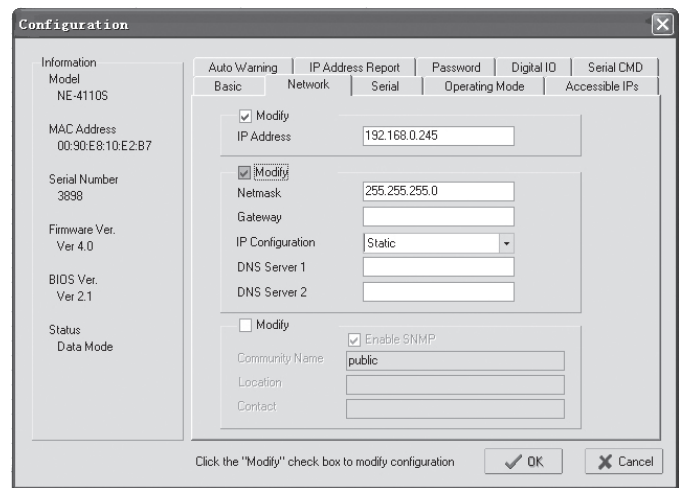

(2) Click Operating Mode option, and select "Modify". Click "Settings", then an operating mode for selection will pop up. Select "Real COM Mode" or "TCP Server Mode", and click "OK".

Operating Mode setting

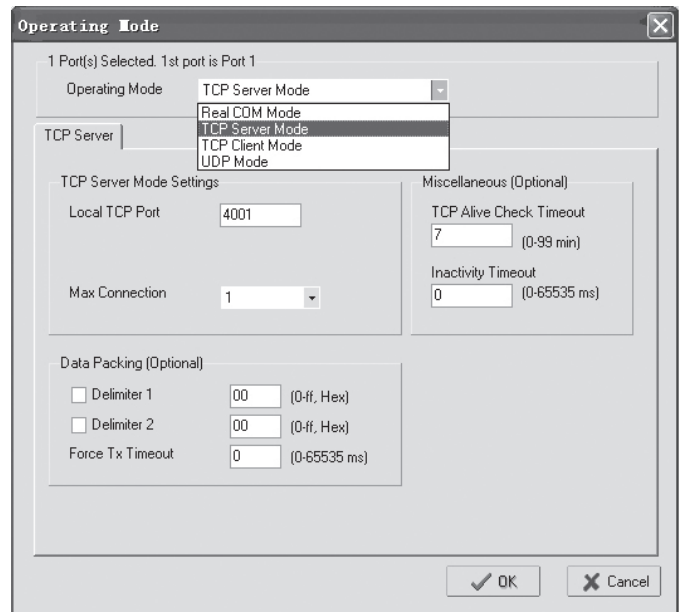



(3) Click Serial option, and set in the pop-up Serial Settings window. The detailed parameters are as follows. Click “OK” after finishing setting.

(4) Click “OK” to finish Configuration setting.

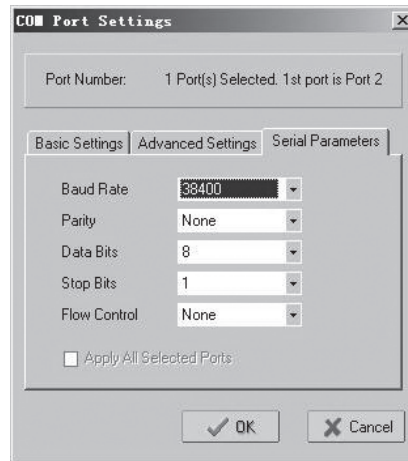
Serial Setting



4. Click “COM Mapping” and “Add target”  to add target instrument. Double click the added instrument in the list of “COM Mapping”, “COM Port Settings” dialog box will appear. Set COM port in “Basic Settings”, change “Mode” to “Classical” in “Advanced Settings”, set “Band Rate” to 38400 in “Searial Parameters, then click “OK” to finish settings. Click “Apply Change”  to save changed setting.

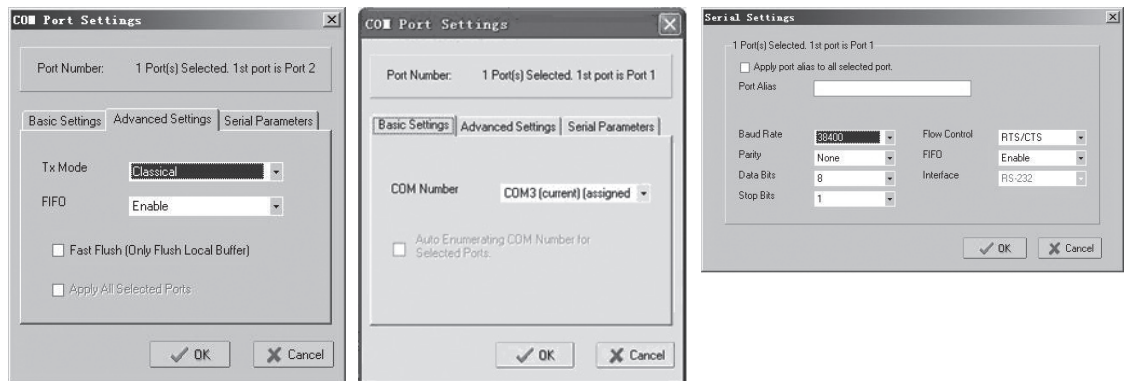

COM port setting

6.3 Software upgrading

First, continuously press the touch screen, and turn on the instrument power. Starting up to enter upgrading status.

Then, run PC software ThermalCycler. Click “tool”- “firmware upgrading” to select lower computer software (. bin) that needs in upgrading.

Select upgraded object and communication mode and instrument address, Communication mode and instrument address press “ 6.2 Network Enable Administrator setting” configuration Settings , and click “upgrading” to start upgrading.

After finishing upgrading, the equipment can be normally operated after restarting.

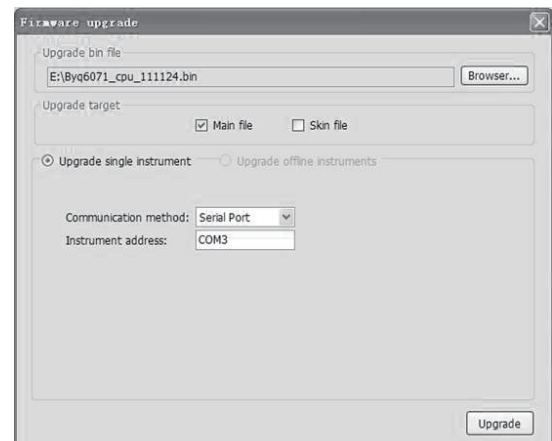

CHAPTER VII FAILURE ANALYSIS AND TROUBLESHOOTING

This chapter mainly introduces possible failures of this instrument and reason analysis as well as troubleshooting.

7.1 Failure Analysis and Troubleshooting

S.N.	Failure	Reason Analysis	Troubleshooting
1	After the power supply switch is turned on, the display screen is not on and the toot sound is not heard either	Power supply is not connected	Check the power supply and connect
		Fuse is burnt	Replace fuse (250V 8A Φ5×20)
		Switch is damaged	Replace switch
		Others	Contact the supplier or the manufacturer
2	During file running process, there is prompt of "Err code:0x**0000****,Please Contact the Manufacturer"	Module sensor is damaged or in poor contact Heat sink sensor is damaged or in poor contact Hot lid sensor is damaged or in poor contact	Contact the supplier or the manufacturer
3	Obvious changes in module heating rate or inaccurate temperature control	The ventilation hole is blocked	Clear obstructions at the vent
		Wires get loose	Open the case, and check the wires. Tighten the screws of wire terminals if they get loose
		Cooling chip is damaged	Contact the supplier or the manufacturer
4	Temperature cooling rate of the module obviously slows down or it cannot slow down under room temperature	The ambient temperature or humidity is so high that they exceed application conditions of the instrument	Please properly adjust the ambient temperature and humidity
		Cooling chip is damaged	Contact the supplier or the manufacturer
		Fan is damaged or out of work	
5	The module neither heats nor cools	The temperature sensor is damaged	Contact the supplier or the manufacturer
		Cooling chips are all damaged	
6	Hot lid cannot heat	In system parameters setting interface, the hot lid status is set as "OFF"	Set the hot lid status at a certain temperature value
		Temperature control in file edition interface is set as "--:--" so that the hot lid automatically closes	Set the temperature time as number form
		Connectors get loose	Contact the supplier or the manufacturer
		Heating elements of the hot lid are damaged	
		Temperature sensor of the hot lid is damaged	
7	The screen shows abnormal characters	Chip is in poor connection	Contact the supplier or the manufacturer
		Chip is broken	

S.N.	Failure	Reason Analysis	Troubleshooting
8	Reagent in reaction tube evaporates	Have not set hot lid temperature, the hot lid is set as "OFF"	Please refer to 4.3 in Chapter IV of the Instruction on Setting Hot Lid Temperature
		The reaction tube is unevenly placed	Adjust hole location of the reaction tube, try to place in a symmetrical way
		The reaction tube is not tightened	Please tighten the reaction tube before placing it into the instrument

S.N.2 Err code: 0x000*** :**

0x	Left sensor	Right sensor	Reserves	Reserves	Reserves	Reserves	Hotlid sensor of single module/ Hotlid A sensor of double module	Hotlid B sensor of double module	Heat sink sensor
----	-------------	--------------	----------	----------	----------	----------	---	-------------------------------------	------------------

0 OK 1 Open circuit alarm 2 Short circuit alarm/Heat sink over temperature alarm

The external environment is too low will cause radiator alarm not instrument anomaly

Caution:

1. The user is not allowed to open the housing of the THERMAL CYCLER for inspection by himself during the warranty period. If any failures that require opening the housing for inspection occur, the supplier or manufacturer should be contacted timely.
2. Since different brands and all instruments have their own temperature control characteristics (including: heating and cooling rate, stability and volatility), and due to the uncertainty of biological experiment and external vulnerability, successful PCR program effect in one instrument may not apply to another. Therefore, when you change the instrument, please adjust PCR running program so as to achieve the ideal state.

Appendix 1: Wiring Diagram (For reference only, and is subject to change without further notice)

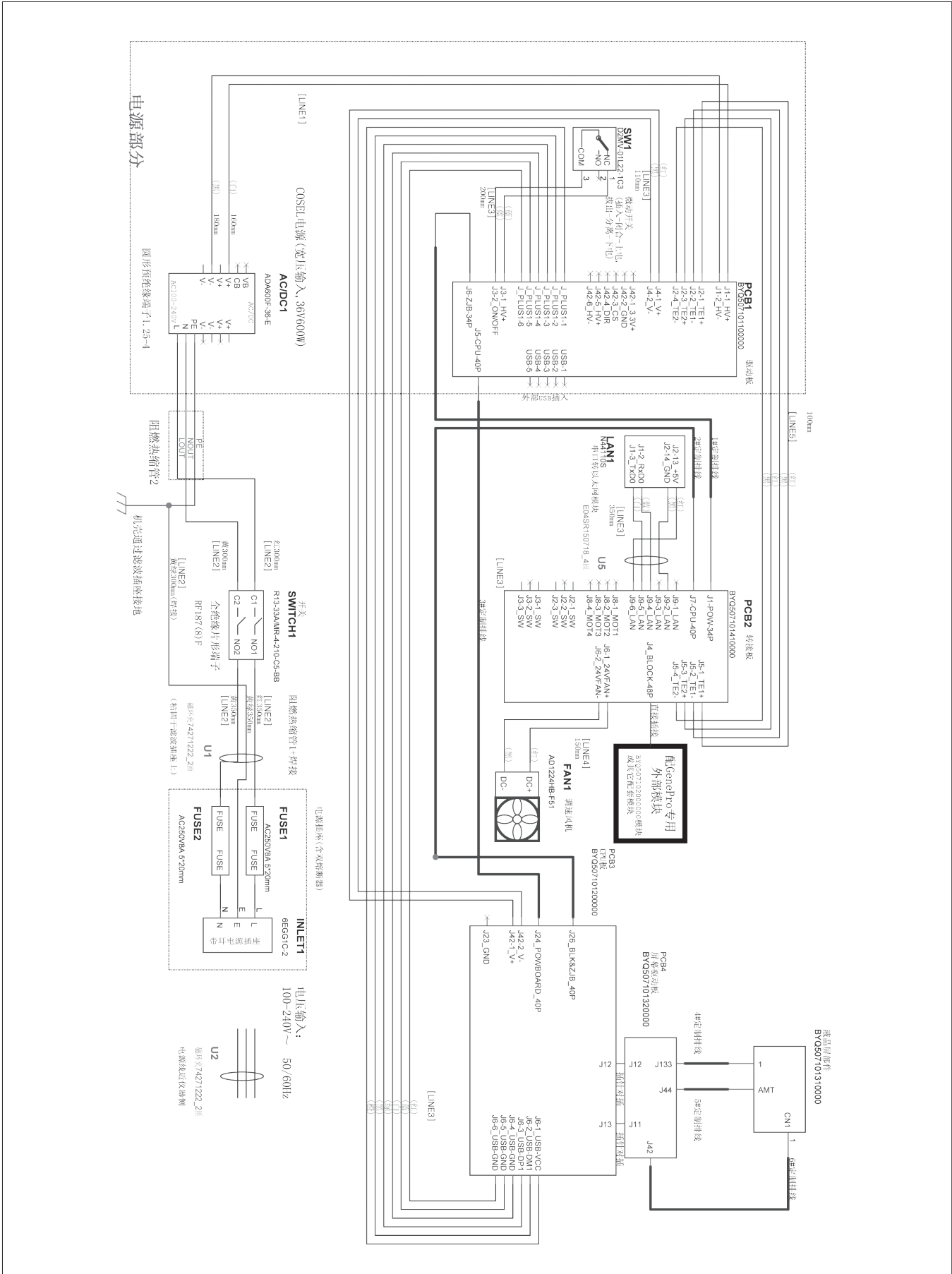

MEMORANDUM

[Empty rectangular box for memorandum content]



BIOER
TECHNOLOGY

Add: 1192 Bin An Rd, Hi-tech (Binjiang) District, Hangzhou
Tel: +86-571-87774575 or 87774303
Fax: +86-571-87772210
E-mail: overseas@bioer.com.cn
P.C.: 310053

